

**MAGTROL**

**GAD Series**

**Large Digital Displays**

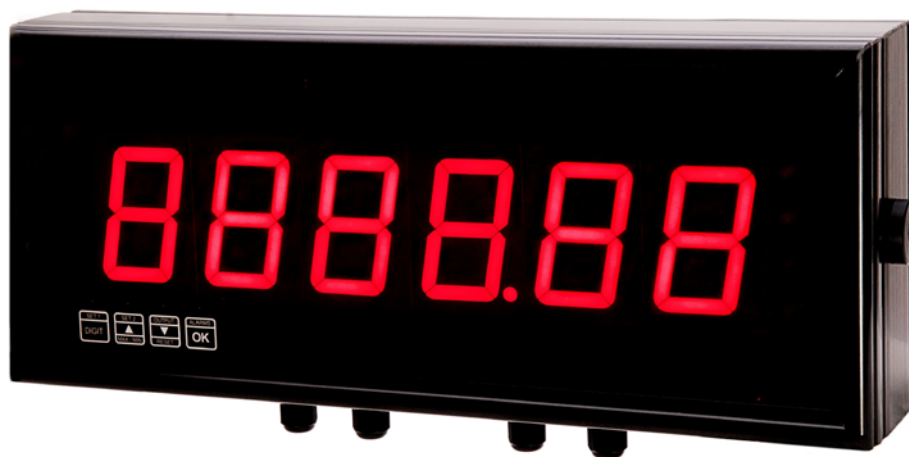

**User's manual**

---

While every precaution has been exercised in the compilation of this document to ensure the accuracy of its contents, Magtrol assumes no responsibility for errors or omissions. Additionally, no liability is assumed for any damages that may result from the use of the information contained within this publication.

**COPYRIGHT**

Copyright ©2012 Magtrol, Inc. All rights reserved.

Copying or reproduction of all or any part of the contents of this manual without the express permission of Magtrol is strictly prohibited.

First Edition – July 2012



---

# Revisions To This Manual

---

The contents of this manual are subject to change without prior notice. Should revisions be necessary, updates to all Magtrol User's Manuals can be found at Magtrol's web site at [www.magtrol.com/support/manuals.htm](http://www.magtrol.com/support/manuals.htm).

Please compare the date of this manual with the revision date on the web site, then refer to the manual's Table of Revisions for any changes/updates that have been made since this edition..

## TABLE OF REVISIONS

DATE	EDITION	CHANGES	SECTION

---

# Table of Contents

---

<b>REVISIONS TO THIS MANUAL .....</b>	<b>I</b>
TABLE OF REVISIONS .....	I
<b>TABLE OF CONTENTS .....</b>	<b>II</b>
<b>PREFACE .....</b>	<b>IV</b>
PURPOSE OF THIS MANUAL .....	IV
WHO SHOULD USE THIS MANUAL .....	IV
MANUAL ORGANIZATION .....	IV
SYMBOLS USED IN THIS MANUAL .....	V
<b>1. INTRODUCTION .....</b>	<b>1</b>
1.1 GENERAL INFORMATION .....	1
1.2 DATA SHEET .....	2
<b>2. INSTALLATION / MOUNTING .....</b>	<b>4</b>
2.1 GENERAL DESCRIPTION .....	4
2.2 SUSPENSION MOUNTING .....	5
2.3 CONNECTIONS .....	6
2.3.1 Input board / power supply board .....	6
2.3.2 Output board .....	7
2.4 INSTALLATION HINTS FOR BEST PERFORMANCE .....	8
<b>3. MENU MODES .....</b>	<b>10</b>
3.1 EASY OR ADVANCED MENU MODE .....	10
3.2 LANGUAGE SELECTION .....	11
3.3 DISPLAY BRIGHTNESS .....	12
3.4 METER CALIBRATION MODE .....	13
3.5 DIRECT CALIBRATION - FULL SCALE SETTING .....	14
3.6 DIRECT CALIBRATION - ZERO SETTING .....	15
3.7 LINEARISATION WITH DIRECT CALIBRATION .....	16
3.8 THEORETICAL CALIBRATION. - DECIMAL POINT & FULL SCALE .....	18
3.9 THEORETICAL CALIBRATION. - LOW END CALIBRATION .....	19
3.10 LINEARISATION WITH THEORETICAL CAL. .....	20
3.11 SENSOR DRIFT CORRECTION .....	22
3.12 LOGIC INPUT FUNCTIONS .....	23
3.13 LOGIC INPUT CONNECTIONS AND FRONT BUTTONS .....	24
3.14 FACTORY DEFAULTS .....	25
3.15 CALIBRATION AUDIT NUMBER .....	25
3.16 SIGNAL FILTERING / AVERAGING .....	26
3.17 FILTER JUMP VALUE .....	27
3.18 LAST DIGIT ROUNDING UP BY 1, 2, 5, 10, 20 OR 50 .....	28
3.19 SCALE FACTOR ADJUSTMENT .....	29
3.20 OFFSET ADJUSTMENT .....	30
3.21 MENU TIMEOUT ADJUSTMENT .....	31
3.22 REVERSE DISPLAY FUNCTION (MIRROR IMAGE) .....	32
3.23 BOOTUP ROUTINE CHOICES .....	33
3.24 ERROR CODES AND FAULT FINDING .....	34

<b>4. OPTION BOARDS .....</b>	<b>35</b>
4.1 HOW TO INSTALL OPTION BOARDS .....	35
<b>APPENDIX A : .....</b>	<b>36</b>
WASTE ELECTRICAL ELECTRONIC EQUIPMENT (WEEE).....	36

---

# Preface

---

## PURPOSE OF THIS MANUAL

This manual has all the necessary information regarding the installation, connection and use of Magtrol's large digital display GAD Serie. To achieve maximum capability and ensure proper use of the system, please read this manual in its entirety before operating. Keep the manual in a safe place for quick reference whenever a question should arise.

## WHO SHOULD USE THIS MANUAL

This manual is for users who want to install and use large digital display GAD Serie for use with different sensor types. The user should have suitable technical training in mechanics and electronics so as to allow him to install and use this display without risk.

## MANUAL ORGANIZATION

This section gives an overview of the structure of the manual and the information contained within it. Some information has been deliberately repeated in different sections of the document to minimize cross-referencing and to facilitate understanding through reiteration.

Summary of the different chapters :

- Chapter 1: INTRODUCTION – Contains the technical data sheet of the large digital display GAD Serie and gives its technical characteristics as well as a brief overview of the application fields.
- Chapter 2: INSTALLATION / MOUNTING – Contains the mounting and configuration explanations for the GAD Serie.
- Chapter 3: MENU MODES – Provides instructions for setup and configuration modes available on the GAD.
- Chapter 4: OPTION BOARDS – Contains operating mode to install option boards.

---

## SYMBOLS USED IN THIS MANUAL

The following symbols and type styles may be used in this manual to highlight certain parts of the text:



---

**Note:** This is intended to draw the operator’s attention to complementary information or advice relating to the subject being treated. It introduces information enabling the correct and optimal function of the product.

---



---

**CAUTION:** THIS IS USED TO DRAW THE OPERATOR’S ATTENTION TO INFORMATION, DIRECTIVES, PROCEDURES, ETC. WHICH, IF IGNORED, MAY RESULT IN DAMAGE TO THE MATERIAL BEING USED. THE ASSOCIATED TEXT DESCRIBES THE NECESSARY PRECAUTIONS TO TAKE AND THE CONSEQUENCES THAT MAY ARISE IF THESE PRECAUTIONS ARE IGNORED.

---



---

**WARNING!** THIS INTRODUCES DIRECTIVES, PROCEDURES, PRECAUTIONARY MEASURES, ETC. WHICH MUST BE EXECUTED OR FOLLOWED WITH THE UTMOST CARE AND ATTENTION, OTHERWISE THE PERSONAL SAFETY OF THE OPERATOR OR THIRD PARTY MAY BE AT RISK. THE READER MUST ABSOLUTELY TAKE NOTE OF THE ACCOMPANYING TEXT, AND ACT UPON IT , BEFORE PROCEEDING FURTHER.

---

---

# 1. Introduction

---

## 1.1 GENERAL INFORMATION

Magtrol Large Digital Displays are used with Load Monitoring Units (LMUs) or signal conditioners (AN Series), as part of a complete measurement system. Magtrol load measuring pins, which measure load and force to provide overload protection, are available for a wide range of Load-Force-Weight, and in various executions and accuracy classes. Combined, these products constitute an ideal safe measurement system for continuous overload monitoring.



## 1.2 DATA SHEET



GAD  
Data Sheet

# GAD Series Large Digital Displays

### FEATURES

- Suspension-mounted large LED display
- Digit Heights: 57, 102, 150, 200, 300, and 400 mm
- Protection class IP 65 (sealed)
- Fully corrosion resistant
- Adjustable brightness
- Power supply: 100 to 240 VAC (optional 11 to 30 VDC or 48 VAC)
- Input: 0 to 10 V, 0 to 5 V or 0 to 20mA, 4 to 20 mA
- Fully scalable in kg, tonne (t), kN, and other engineering units
- Auto-tare function
- Optional voltage (0 to 10 V) or current (4 to 20 mA) output
- Optional RS-232 serial output

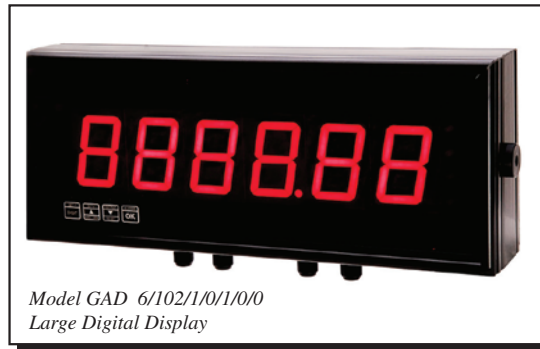

### LOAD-FORCE-WEIGHT SYSTEMS

Magtrol Large Digital Displays are used with Load Monitoring Units (LMUs) or signal conditioners (AN Series), as part of a complete measurement system. Magtrol load measuring pins, which measure load and force to provide overload protection, are available for a wide range of Load-Force-Weight, and in various executions and accuracy classes. Combined, these products constitute an ideal safe measurement system for continuous overload monitoring.

### DESCRIPTION

These high quality, large character digital displays can be used for crane weight display, process weight display, and all other remote weighing applications. They use microprocessor based technology for high reliability and have a non-volatile memory to store all the calibration data.

### SYSTEM CONFIGURATION

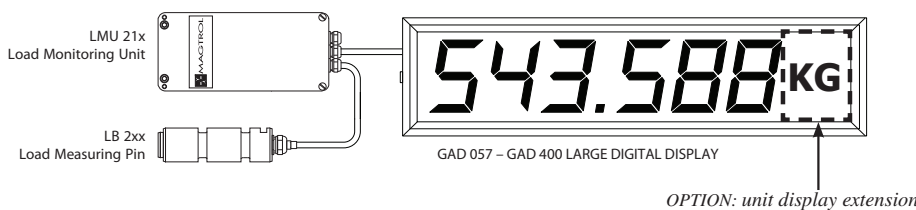

### DIMENSIONS

MODEL	Digits	Digit Height	Viewing Distance	Dimensions of the Display				Weight	
				Width		Height*	Depth	4 digits	6 digits
				4 digits	6 digits				
mm	m	mm	mm	mm	mm	kg	kg		
GAD 057 **	4 or 6	57	20	279.5	376	154.5	77	1.3	1.7
GAD 102	4 or 6	102	40	434	616	195.5	77	3.1	3.9
GAD 150	4 or 6	150	60	580	820	246	77	3.9	4.3
GAD 200	4 or 6	200	80	750	1072	290	77	4.7	6.4
GAD 300	4 or 6	300	120	1050	1540	408	77	10.6	14.9
GAD 400	4 or 6	400	160	1368	2020	515	77	13.0	16.0

\* The display height does not include the stuffing glands, which are approximately 25 mm (1 inch) high.

\*\* For the model GAD 057 with 4 digits, adding an optional module requires the unit display extension option.

# Specifications and Ordering Information

GAD

## RATINGS

SIGNAL PROCESSING	
Voltage input: • Input range • Input impedance	0 to 10 V, 0 to 5 V, 1 to 5 V 1 MΩ
Current input: • Input Range • Input Impedance	0 to 10 mA, 0 to 20 mA, 4 to 20 mA 33 Ω
MEASUREMENT DISPLAY	
Type	7 segments
Display definition	-1999 to 9999 (4 digits) or -199999 to 999999 (6 digits)
Digits/Color	4 or 6 digits/red
Scaling	Digital zero and full scale adjustable by programming keys
Decimal point	Position adjustable by programming keys
Filtering/Signal smoothing	Time constant adjustable between 0 and 25 seconds
Count-by function	Round-off of the last digits with steps of 1, 2, 5, or 10
ACCURACY	
Resolution	1/400000
Maximum error	±0,05% of full scale
Stability	±25 ppm/°C (full scale) and ±30 ppm/°C (offset)
Reading rate	10 readings per second
Response time	0.1 seconds
POWER SUPPLY	
AC	100 to 240 VAC 45/60 Hz, (option) 48 VAC
DC (option)	11 to 30 VDC
Power consumption	40 VA max.
ENVIRONMENTAL AND MECHANICAL CHARACTERISTICS	
Operating temperature	0°C to +50°C (down to -25°C as an option)
Storage temperature	-20°C à +70°C
Protection Class	IP 65

## ORDERING INFORMATION

Model Number:

GAD  /  /  /  /  /

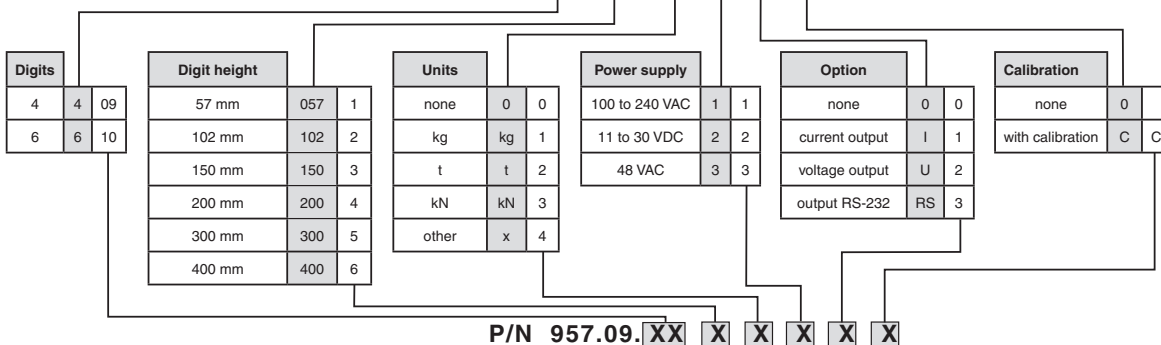

Due to the continual development of our products, we reserve the right to modify specifications without forewarning.



[www.magtrol.com](http://www.magtrol.com)

**MAGTROL INC**  
70 Gardenville Parkway  
Buffalo, New York 14224 USA  
Phone: +1 716 668 5555  
Fax: +1 716 668 8705  
E-mail: magtrol@magtrol.com

**MAGTROL SA**  
Route de Montena 77  
1728 Rossens/Fribourg, Switzerland  
Phone: +41 (0)26 407 3000  
Fax: +41 (0)26 407 3001  
E-mail: magtrol@magtrol.ch

**Subsidiaries in:**  
Germany • France  
China • India  
Worldwide Network  
of Sales Agents



GAD-US 01/12

---

## 2. Installation / Mounting

---

### 2.1 GENERAL DESCRIPTION

To be made, such a weight, temperature, pressure, humidity etc. Different models are available for different sensor types. The main function of this series is to give a clear numeric readout of the variable being monitored. Most models include an excitation power output, to power the sensor directly. Various digit heights are available, to suit the maximum viewing distance required in each installation. For every 10 metres of viewing distance required, use 1" of digit height.

Various optional output modules are also available to give alarm relay outputs, analogue output or digital communications, or any combination of these options. Displays are programmed using front panel pushbuttons. The front panel buttons can be disabled. In addition, you can connect 4 remote wired pushbuttons to the display, so that you can make adjustments while the display is mounted in an inaccessible location.

Power supply options : 100-240 VAC, 48VAC or 11-30VDC

These displays must be installed fully assembled, and must be installed according to local electrical installation rules.

When properly installed, and provided they have been ordered with cable glands exiting the lower surface of the case, they provide ingress protection to IP65 / NEMA4X from all directions.

## 2.2 SUSPENSION MOUNTING

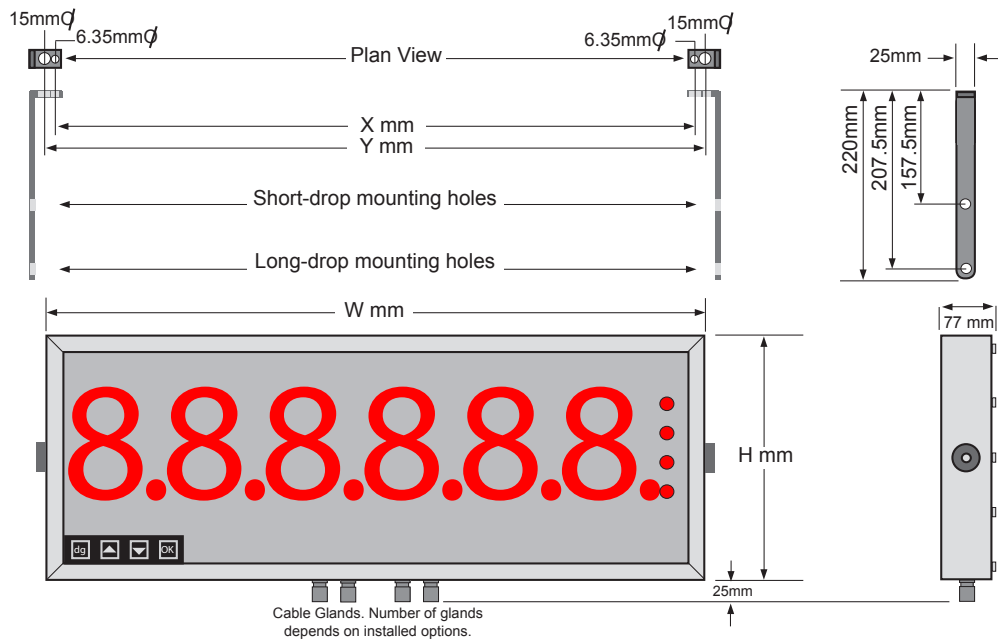

### Detail showing bracket hardware fitting sequence

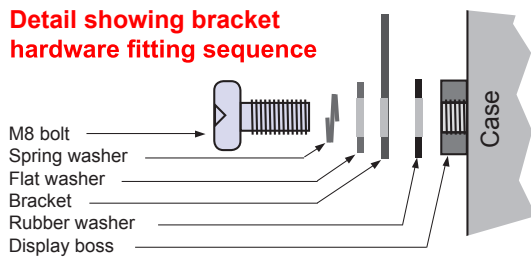

You can order these displays with the cable glands in the bottom surface (as shown) the rear, or top.

Rear glands allow you to mount the display on top of a cubicle, using the brackets

Display format mm	X mm	H mm	W mm	Y mm
57 - 4 digits digital	233.5	154.5	279.5	263.5
57 - 6 digits digital	330	154.5	376	360
102 - 4 digits digital	388	195.5	434	418
102 - 6 digits digital	570	195.5	616	600
150 - 4 digits	534	246	580	564
150 - 6 digits	774	246	820	804
200 - 4 digits	704	290	750	734
200 - 6 digits	1026	290	1072	1056
300 - 4 digits	1004	408	1050	1034
300 - 6 digits	1494	408	1540	1524
400 - 4 digits	1322	515	1368	1352
400 - 6 digits	1974	515	2020	2004

## 2.3 CONNECTIONS

### 2.3.1 Input board / power supply board

There is a wide range of possible locations for the input board, output board and power supply board/s. Their locations depend on the height of digits, number of digits, brightness of digits and any installed options. Because the permutation of possible locations is large, we will not describe the location of boards within the display, but simply identify the connectors and their functions on each board, below ...



**WARNING ! DISCONNECT ALL POWER BEFORE REMOVING THE REAR OF THE DISPLAY**

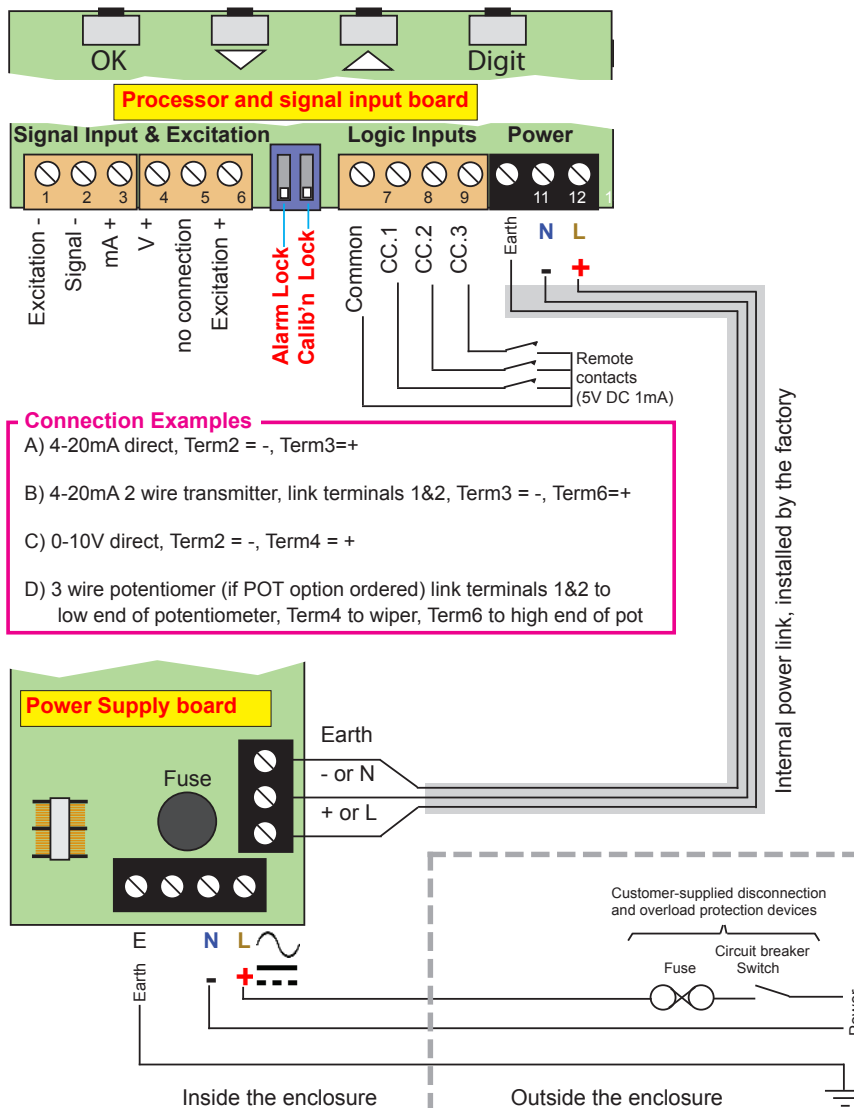

2.3.2 OUTPUT BOARD



CAUTION CONNECTORS MAY BE PRESENT EVEN IF OUTPUT OPTIONS ARE NOT INSTALLED. REFER TO RATING LABEL TO SEE INSTALLED OPTIONS.



WARNING ! DISCONNECT ALL POWER BEFORE REMOVING THE REAR OF THE DISPLAY

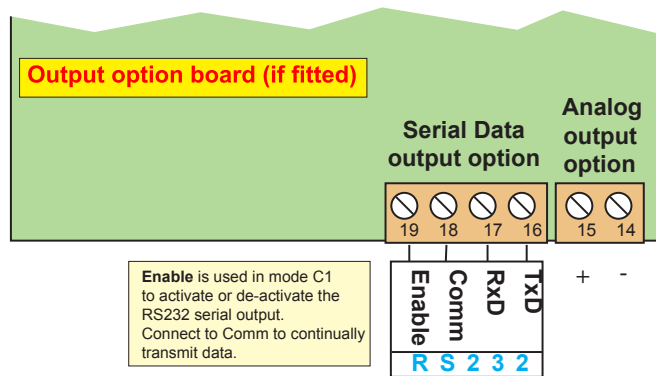

Remote programming button connector

On one of the display boards, you will find a 7 way connector, to which you can wire remote programming buttons, to allow adjustment of the display’s settings when the display is inaccessible.

You can also enable or disable the display’s front panel buttons, either by a remote contact closure, or by an on-board push-on jumper switch, which is located near to the remote button connector. When the contact is closed, or the push-on switch fitted, the front buttons are enabled.

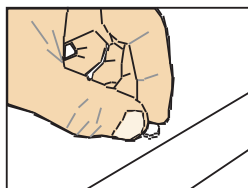
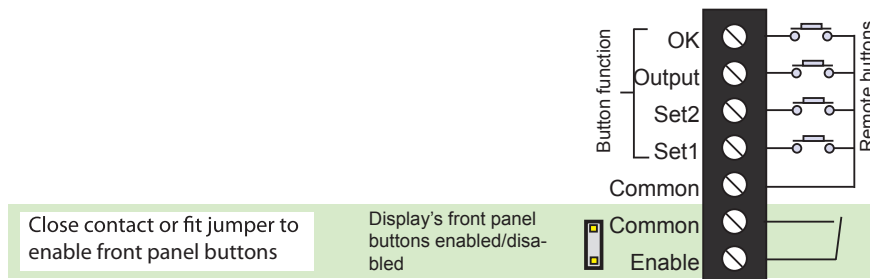

Rear case screws - please note

The rear panel is held in place with finger-screws, which only need to be gently tightened. Do not use tools to tighten or loosen the screws, as this could cause damage to the internal threads.

## 2.4 INSTALLATION HINTS FOR BEST PERFORMANCE

This section offers several suggestions which will help you get the best performance from your measurement system. Some sensors generate comparatively small signals which can easily be corrupted by the potentially high level of electrical noise which can be created by electrical machinery such as motors, welding systems, discharge lighting, AC power inverters and solenoids. These steps will ensure you get the best possible performance from your system.

1. Use good quality screened signal cable K-414.
2. If you are using multi-pair twisted cable, each pair should be dedicated to a single display as shown opposite, for maximum noise immunity. This will ensure that any electrical noise induced in the cable is properly cancelled. Mixing destinations carelessly amongst the twisted pairs can actually worsen noise performance.
3. The cable should be routed away from noisy wiring and devices such as power feeds from inverters, discharge-lighting cables, welder cabling etc, and should preferably be routed in a dedicated low voltage signalling/instrumentation conduit or cable tray.
4. Screened cable should be earthed at the display end only.
5. All wires and screens coming out of the screened cable should be kept as short as possible to minimise pickup of noise.
6. If you are using barriers, you should earth your screen as shown below, paying particular care that you do not earth both ends of any run of of cable.

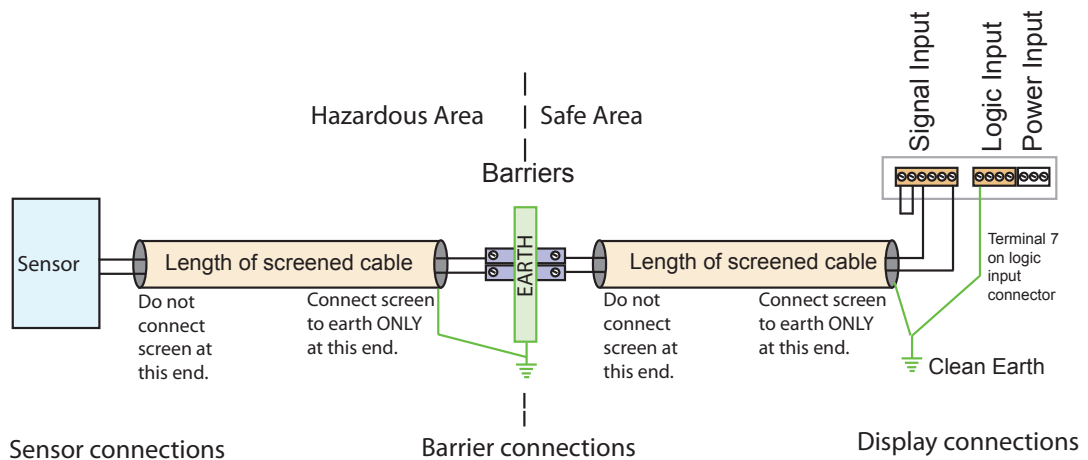

When using multi-core screened cable to connect several displays to several sensors, please be sure to use one twisted pair for each display and sensor.



Note: Do NOT use a wire from one pair for signal positive and a wire from another pair for signal negative, as this will prevent the twisted cables from cancelling any induced electrical noise.

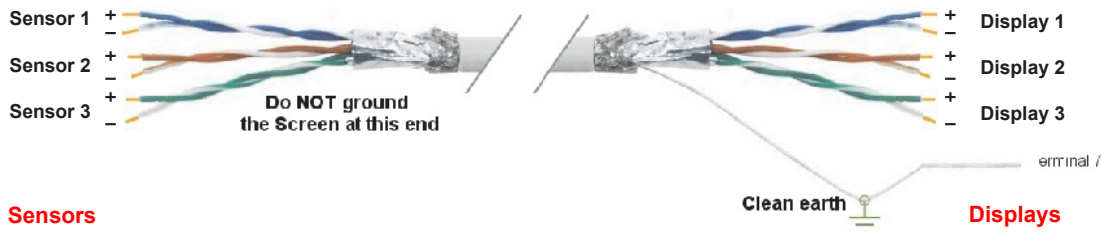



---

## 3. Menu modes

---

### 3.1 EASY OR ADVANCED MENU MODE

You can choose from two menu modes.

**1. Easy Mode** - This limits the menu to the most commonly required features, in order to make it less complex and easier to navigate. This is the default level.

**2. Advanced Mode** - This gives you access to all available menu features.

Each menu feature in this manual has a **heading note** to tell you whether it is available in Easy or Advanced mode.

How to choose menu mode:

**This feature is available in Easy and Advanced Modes**

- 1**  
Set1 Digit, Set2 Max/Min, Output, Alarms OK  
Lockout Switch must be OFF  
Circuit board ON  
Press together briefly
- 2**  
Set1 Digit, Set2 Max/Min, Output Reset, Alarms OK  
Press OK a few times, until you see **Adv.** or **EASy**  
Press briefly
- 3**  
Set1 Digit, Set2 Max/Min, Output, Alarms OK  
Each press of the DOWN arrow, or UP arrow will alternate between showing **Adv.** or **EASy**  
Press to toggle
- 4**  
Set1 Digit, Set2 Max/Min, Output Reset, Alarms OK  
Press OK to select your choice.  
Done!  
Press to accept

### 3.2 LANGUAGE SELECTION

You can select English or French menu prompts.

**1** This feature is available in Easy and Advanced Modes

Set1 Digit Set2 Max/Min Output OK Alarms

Lockout Switch must be OFF

OFF ON

Circuit board

Press together, briefly

**2**

Set1 Digit Set2 Max/Min Output OK Alarms

Display shows

UI Eng (Default)  
for User Interface English  
or  
UI FrA  
for User Interface French

Press to toggle

**3**

Set1 Digit Set2 Max/Min Output Reset Alarms OK

Done!

Press to accept

### 3.3 DISPLAY BRIGHTNESS

**This feature is available in Easy and Advanced Modes**

**1**

Set1 Digit Set2 **UP** Min Output Reset Alarms OK Lockout Switch must be ON

Press 3 seconds

Circuit board ON

**2**

Set1 Digit Set2 **UP** Min Output Reset Alarms OK

Press for 3 seconds

Display shows **bright**  
Each press of the UP button will select a new brightness level. There are 7 brightness levels to choose from.  
(Default = Full brightness)

**3**

Set1 Digit Set2 Max/Min Output Reset Alarms OK

Press to accept

**Done!**

### 3.4 METER CALIBRATION MODE

You can choose from two main calibration methods.

1. Direct Calibration - this is when you connect the meter to your system and make the meter read what you want it to, at 2 different points. This is the preferred calibration method, because it allows you to calibrate the system as a whole.
2. Theoretical Calibration - this is when you type in the sensor’s theoretical signal level at the bottom and top of its range and then type in the value the display should show, for each signal level

**This feature is available in Easy and Advanced Modes**

**1**

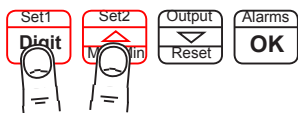

Press 3 seconds

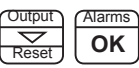

**Lockout Switch must be OFF**



OFF

Circuit board ON

**2**



Press to select dirECt or thEor

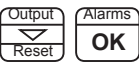

Display shows **CAL Src** then  
**dirECt**  
or  
**thEor** (Default)

**3**

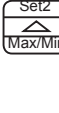

Press to accept

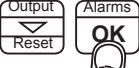

If you chose Theoretical, you will now be asked whether your input signal will be DC Current or DC voltage ... the display will show **Input** followed by **dC A** or **dC V**

**4**



Press to select dc A or dc V

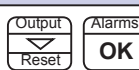



Display shows **Input** then  
**dC A** for current or  
**dC V** for voltage (Default)

**5**

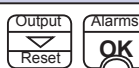

Press to accept





**Done!**

### 3.5 DIRECT CALIBRATION - FULL SCALE SETTING

This is when you connect the meter to your system and make the meter read what you want it to, at 2 different points. *This is the preferred calibration method, because it allows you to calibrate the system as a whole.*

How to do direct calibration:-

If you have not done so before, please select Direct Calibration mode from the previous page.

First we recommend you set the **FULL SCALE** calibration ...

**This feature is available in Easy and Advanced Modes**

- # 1

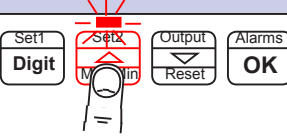

Press 3 seconds

**Lockout Switch must be OFF**  
Display shows **direCt** followed by **SEt Hi**

Circuit board

ON

OFF
- # 2

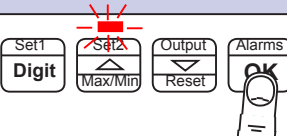

Apply the highest calibration signal you can achieve, ideally 100% of system capacity. You can use less, but you will get better accuracy with higher signals.
- # 3

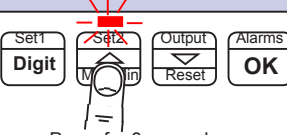

Press for 3 seconds

Press Set2 for 3 seconds. You can now set your decimal point position using the UP or DOWN buttons. Press OK when done.
- # 4

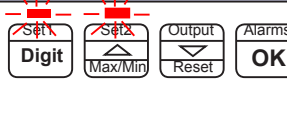

You can now set the display value you want to see - use DIGIT to select each digit in turn, and the UP or DOWN arrow to increase or decrease each digit's value, as required.
- # 5

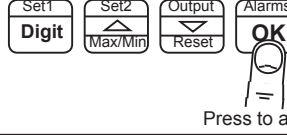

Press to accept

✓

**Done!**

### 3.6 DIRECT CALIBRATION - ZERO SETTING

How to calibrate the ZERO point.

**This feature is available in Easy and Advanced Modes**

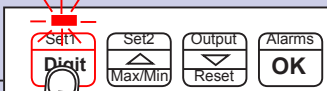
- 

Press 3 seconds

Lockout Switch must be OFF 

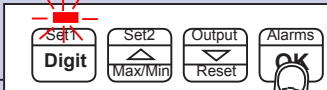
Circuit board ON 
- 

Display shows **direCt** followed by **set Lo**

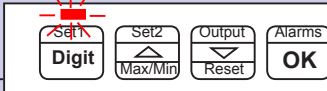
Apply the lowest calibration signal you can achieve, ideally 0% of system capacity. Now press OK
- 

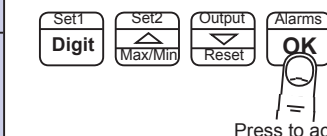
You can now set the display value you want to see - use DIGIT to select each digit in turn, and the UP or DOWN arrow to increase or decrease each digit's value, as
- 

Press to accept

 **Done!**

### 3.7 LINEARISATION WITH DIRECT CALIBRATION

If your system is non linear, you can calibrate the meter and correct for this with the lineariser function. You will need to apply a series of known loads, starting at 0 and working up to full scale. You will then tell the meter what it should read for each applied load. You can use up to 10 points. First, you must select Direct Calibration Mode (see page on calibration Modes) then, proceed as shown below...

**This feature is available in Easy and Advanced Modes**

**1**

**Lockout Switch must be OFF**

Display will show **Lin.On** or **Lin.OFF** (Default)

Circuit board

OFF

ON

Press together, briefly

**2**

If the display shows **Lin.OFF**, press Set2 button briefly so that the display shows **Lin.On**, then press OK

**3**

The display will show **SEt 00**

Ensure no load is applied to the system and press OK.

The display will now show **rd 00**

You can now tell the meter what it should display for this load.

Select each digit in turn with the DIGIT button, and increase or decrease each digit's value using the UP or DOWN button, until the display is set as required. Press OK when done.

**4**

The display will show **Add.Pt**

Press OK

Continued ...

linearisation with direct calibration (cont'd)

5

Digit

Max/Min

Reset

OK

Apply your 1st known load to the system and press OK.

The display will now show **rd 01**  
You can now tell the meter what it should display for this load.

Select each digit in turn with the DIGIT button, and increase or decrease each digit's value using the UP or DOWN button, until the display is set as required. Press OK when done.

6

Set1  
Digit

Set2  
↑

Output  
↓  
Reset

Alarms  
OK

The display will show **Add.Pt**

Press OK if you want to Add another calibration point, you will repeat the previous steps, each time incrementing "Set XX" and "rd XX" up to Set 09 and rd 09 which are the last available points.

If you want to finish adding points, press Set2 until the display shows **SAVE**, and then confirm by pressing OK

If you want to abort the setup, press Set2 until the display shows **quit** and then press OK

7

Set1  
Digit

Set2  
↑

Output  
↓

Alarms  
OK

✓

Input Point	Display Reading (rd)
Set00	rd 00
Set01	rd 01
Set02	rd 02
Set03	rd 03
Set04	rd 04
Set05	rd 05
Set06	rd 06
Set07	rd 07
Set08	rd 08

17



### 3.8 THEORETICAL CALIBRATION. - DECIMAL POINT & FULL SCALE

This is when you type in the sensor’s theoretical signal level at the top and bottom of its range and the value to display, for each signal level.



**CAUTION:** IF YOU HAVE NOT DONE SO BEFORE, PLEASE SELECT THEORETICAL CALIBRATION MODE FROM THE METER CALIBRATION PAGE AND CHOOSE WHETHER YOUR INPUT IS CURRENT OR VOLTAGE. FIRST WE RECOMMEND YOU SET THE FULL SCALE CALIBRATION ...

**This feature is available in Easy and Advanced Modes**

- Lockout Switch must be OFF

Press 3 seconds
- Display shows **theor** followed by **dC A** or **dC V**, depending on whether you have chosen current or voltage input, then **In Hi**
- You can now specify the maximum input signal. Use DIGIT to select each digit in turn, and the UP or DOWN arrow to increase or decrease each digit’s value, as required. eg set **20.0000** if your input is 4-20mA

Press to accept
- Display now shows **rd Hi** briefly. You can now specify the maximum reading and decimal point position. Press Set2 button for 3 seconds to set decimal point position. Use up and down arrows to move the decimal point and press OK when done. Then, use DIGIT to select each digit in turn, and the UP or DOWN arrow to increase or decrease each digit’s value, as required. eg set 100.000 if your display range is 0 to 100.000

Defaults are  
4-20mA = 0-100.00 for dCA  
and  
0-10V = 0-100.00 for dC V
- Press to accept

**Done!**

### 3.9 THEORETICAL CALIBRATION. - LOW END CALIBRATION

This is when you type in the sensor’s theoretical signal level at the top and bottom of its range and the value to display, for each signal level. If you have not done so before, please select Theoretical Calibration mode from the Meter Calibration page.

**This feature is available in Easy and Advanced Modes**

# 1

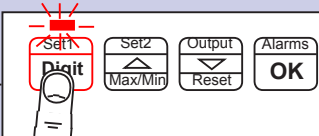

**Lockout Switch must be OFF** OFF  
ON

Circuit board ON

Press 3 seconds

# 2

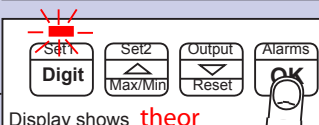

Display shows **theor** followed by **dC A** or **dC V**, depending on whether you have chosen current or voltage input, then **In Lo**

Press OK. You can now specify the lowest input signal. Use DIGIT to select each digit in turn, and the UP or DOWN arrow to increase or decrease each digit’s value, as required. eg set **04.0000** if your input is 4-20mA

# 3

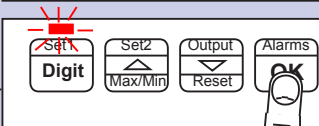

Press to accept

# 4

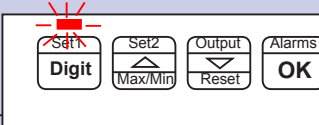

Display now shows **rd Lo** briefly. You can now specify the low reading.

Use DIGIT to select each digit in turn, and the UP or DOWN arrow to increase or decrease each digit’s value, as required. eg set **000.000** if your display range is 0 to 100.000

# 5

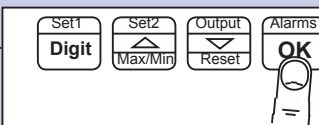

Press to accept



**Done!**

You can set Zero first, if you prefer, but you will not be able to change the decimal point position in the ZERO calibration step. This will not be an issue if your zero calibration reading is 0, but may become confusing

### 3.10 LINEARISATION WITH THEORETICAL CAL.

If your system is non linear, you can calibrate the meter and correct for this with the lineariser function. With this method, you can enter theoretical values for input signal and display values, without having to connect a sensor. First, you must select Theoretical Calibration Mode (see page on calibration Modes) Then, proceed as shown below...

**This feature is available in Easy and Advanced Modes**

- 1

Set1  
Digit

Set2  
Max/Min

Output  
Reset

Alarms  
OK

**Lockout Switch must be OFF**

Display will show  
**Lin.On** or **Lin.OFF**

OFF



ON

Press together, briefly
- 2

Set1  
Digit

Set2  
Max/Min

Output  
Reset

Alarms  
OK

If the display shows **Lin.OFF**, press Set2 button briefly so that the display shows **Lin.On**, then press OK
- 3

Set1  
Digit

Set2  
Max/Min

Output  
Reset

Alarms  
OK

The display will show **In 00** followed by an editing screen. Here you can enter your first calibration input signal level using DIGIT button to select each digit in turn. Increase or decrease the value of each digit using the UP or DOWN buttons. Press OK when set.

The display will now show **rd 00**  
You can now tell the meter what it should display for this input signal.

Select each digit in turn with the DIGIT button, and increase or decrease each digit's value using the UP or DOWN button, until the display is set as required. Press OK when done.
- 4

Set1  
Digit

Set2  
Max/Min

Output  
Reset

Alarms  
OK

Display will show **Add.Pt**

Press OK

Continued ...

Linearisation with Theoretical Cal. (cont'd)

5

Set1  
Digit

Set2  
Max/Min

Output  
Reset

Alarms  
OK

The display will show **In 01** followed by an editing screen. Here you can enter your next calibration input signal level using DIGIT button to select each digit in turn. Increase or decrease the value of each digit using the UP or DOWN buttons. Press OK when set.

The display will now show **rd 01**  
You can now tell the meter what it should display for this input signal.

Select each digit in turn with the DIGIT button, and increase or decrease each digit's value using the UP or DOWN button, until the display is set as required. Press OK when done.

6

Set1  
Digit

Set2  
Max/Min

Output  
Reset

Alarms  
OK

The display will show **Add.Pt**

Press OK if you want to Add another calibration point, you will repeat the previous steps, each time incrementing **In XX** and **rd XX** up to In 09 and rd 09 which are the last available points.

If you want to finish adding points, press Set2 until the display shows **SAVE**, and then confirm by pressing OK

If you want to abort the setup, press Set2 until the display shows **qUit** and then press OK

**Done!**

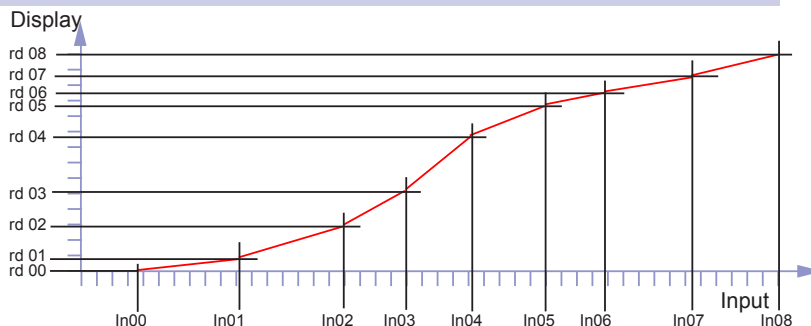

### 3.11 SENSOR DRIFT CORRECTION

If your system is normally reading 0, for example as is typical with platform scales or a torque meter, you may find a small amount of sensor drift caused by changes in temperature, ageing etc. We can automatically correct for slow, long term drift, by comparing your signal to 0 every 30 seconds, and re-calibrating to remove any detected movement. This does not affect the sensitivity of your system, and is only applied for readings less than 8 least-significant counts. The corrected value is stored in non-volatile memory, so that any drift trend will be reapplied after you have switched off the meter.

This feature is available in Easy and Advanced Modes

- 1

Set1  
Digit

Set2  
Max/Min

Output  
T

Alarms  
T

**Lockout Switch must be OFF**



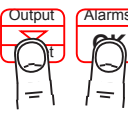

Press together, briefly

Circuit board



- 2

Set1  
Digit

Set2  
Max/Min

Output  
Reset

Alarms  
OK



Press OK button briefly and repeatedly until you see **drift.0** or **drift.1** displayed.
- 3

Set1  
Digit

Set2  
Max/Min

Output  
Reset

Alarms  
OK



Press DOWN or UP button to toggle between **drift.0** or **drift.1**

**drift.0** = No Correction (Default)  
**drift.1** = Correction is active
- 4

Set1  
Digit

Set2  
Max/Min

Output  
Reset

Alarms  
OK





**Done!**

### 3.12 LOGIC INPUT FUNCTIONS

The three contact closure inputs on the rear of the meter have default functions which are:

- Contact closure 1 = Tare
- Contact closure 2 = Peak/Valley display
- Contact closure 3 = Reset

You can re-assign these to include :HOLD, Nett/Gross value display, Memory

!! This feature is available in Advanced Mode only !!

**1**

Set1  
Digit

Set2  
Max/Min

Output  
Reset

Alarms  
OK

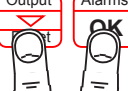

Press 3 seconds

**Lockout Switch must be OFF**

OFF



Circuit board

ON

**2**

Set1  
Digit

Set2  
Max/Min

Output  
Reset

Alarms  
OK



Press repeatedly until you see **CC.1** , followed by the existing function for Contact Closure 1.

After you have set **CC.1** , you will get the prompt **CC.2** to allow you to set Contact Closure 2 function and when you have set CC.2 you will get the prompt **CC.3** to allow you to set Contact Closure 3 func-

**3**

Set1  
Digit

Set2  
Max/Min

Output  
Reset

Alarms  
OK



Use UP or DOWN buttons to select from these available functions...

	<b>tare</b>	= Tare display to 0
	<b>PV</b>	= Peak/Valley toggle
	<b>rst</b>	= Reset
	<b>HoLd</b>	= Freeze display
	<b>net.gro</b>	= Nett / Gross display
	<b>PA.1</b>	= Page Address 1*
	<b>PA.2</b>	= Page Address 2*
	<b>PA.4</b>	= Page Address 4*

Defaults are:-  
**CC.1 = tare**  
**CC.2 = PV**  
**CC.3 = rst**

**4**

Set1  
Digit

Set2  
Max/Min

Output  
Reset

Alarms  
OK



Press to accept



**Done!**

\* Only available if the Multi-memory MEM option is installed

### 3.13 LOGIC INPUT CONNECTIONS AND FRONT BUTTONS

The previous page explained how to select the functions of the 3 logic inputs. You can connect remote contact closures or open NPN collectors to activate these logic inputs. The logic input provides a 5V DC signal. When you connect this to common, a current of 1mA will flow. Because this is a small signal, we recommend you use switches with gold plated contacts, or self cleaning contacts, for best long term reliability.

The logic inputs **ARE NOT** galvanically isolated from the input signal.

The logic inputs are **only activated when the lockout switch is ON**

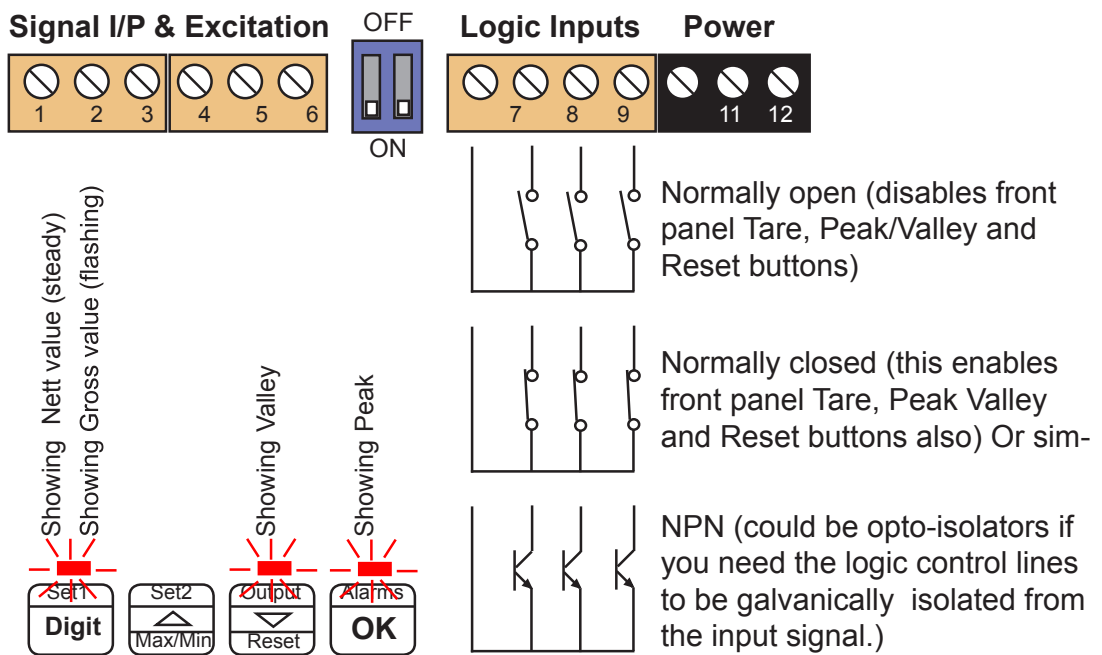

**tare** = Tares display to 0. Often used in weighing systems to zero a display prior to making a measurement. Net weight is shown once tared. When a display has been tared the small LED above the Set1 button will be illuminated.

**PV** = Peak/Valley toggle. Allows you to view the maximum and minimum values which have been displayed since last reset. 0% LED illuminates when showing valley, 100% LED illuminates when showing peak.

**rst** = Reset. This clears any tare, peak, valley, alarm latch

**HoLd** = Freezes the displayed value for as long as the Hold input is closed

**net.gro** = Allows you to toggle between Nett and Gross values on the display

### 3.14 FACTORY DEFAULTS

You can return the display to its factory default conditions whenever you wish. If you do so, you will permanently lose all your settings and will need to start from the beginning again. The calibration Audit Counter will NOT be reset, there is no way provided to reset this value, as it is intended as a secure record to indicate whether changes have been made

**This feature is available in Easy and Advanced Modes**

# 1

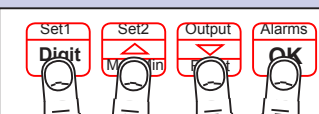

Press together for 3 seconds

**Lockout Switch must be OFF**

OFF



Circuit board ON

---

# 2

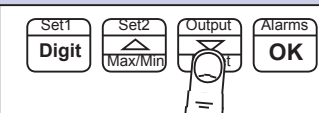

Display shows :-  
**defs n** (Defaults no)

Press the DOWN button to change the display to **defs y** (Defaults Yes) if you want to return to default conditions.

---

# 3

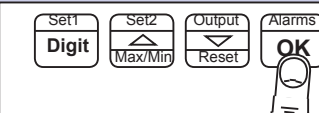

Press to accept



**Done!**

### 3.15 CALIBRATION AUDIT NUMBER

Your display includes a non-resettable counter which increments each time you make a change to the display's calibration. This is useful if you want to check whether a display has been altered since it was last calibrated. The Calibration audit number starts at CAL 01 up to CAL FF allowing up to 255 alterations to be recorded. Whenever you want to check the calibration audit number, press and hold the 2 outer buttons (Set1 + Alarms) for more than 3 seconds.

# 1

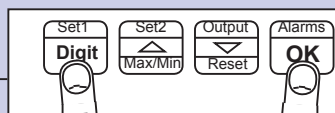

Press together for 3 seconds



**Done!**



### 3.16 SIGNAL FILTERING / AVERAGING



**CAUTION**

YOU CAN ADJUST THE FILTERING TIME CONSTANT TO REDUCE THE EFFECT OF NOISE OR INSTABILITY ON YOUR INPUT SIGNAL. A LARGER FIL VALUE WILL GIVE A MORE STABLE DISPLAY, **BUT THE RESPONSE TO SIGNAL CHANGES WILL BE SLOWER. BECAUSE YOUR OUTPUT OPTIONS, SUCH AS ANALOGUE OUTPUT AND SERIAL OUTPUT ARE ALL DERIVED FROM THE DISPLAYED VALUE, THEY WILL RESPOND AT THE SAME RATE AS THE FILTERED DISPLAY.**

**This feature is available in Easy and Advanced Modes**

1

Set1  
Digit

Set2  
Max/Min

Output  
Reset

Alarms  
OK

**Lockout Switch must be OFF**





Press 3 seconds

Circuit board **ON**

2

Set1  
Digit

Set2  
Max/Min

Output  
Reset

Alarms  
OK

Display shows **HFI.X** where **X** is the amount of basic filtering.  
**A=Low b=Medium C=High d=Most**  
 (Default = **HFI.C**)



Select, then press OK to accept

3

Set1  
Digit

Set2  
Max/Min

Output  
Reset

Alarms  
OK

Display shows **FIL.XX.X** where **XX.X** is the time constant in seconds.  
 Use the UP or DOWN button to increase or decrease this value



Select, then press OK to accept

4

Set1  
Digit

Set2  
Max/Min

Output  
Reset

Alarms  
OK

**Done!**





Press to accept

See also Filter Jump setting in the Advanced Menu, if your signal is particularly noisy and you cannot get sufficient smoothing with this filter.

### 3.17 FILTER JUMP VALUE

See the Easy/Advanced mode selection page near the beginning of this manual, and choose advanced mode. The Filter Jump value allows you to decide how the display will respond to a process step change. It does this by overriding the filtering, if the input signal moves by more than a chosen amount in one conversion. **The Filter Jump default value is 10%.** This means that for noise amplitude which has a peak value of less than 10% of the input range, filtering will be applied. Any signal movement greater than 10% of the input range will cause the display to jump immediately to that value, without filtering. After that jump, normal filtering will be re-applied, provided signal movement thereafter is less than 10% per conversion.

**Guidance:** For noisy systems, increase the Filter Jump value up to a maximum of 99. Choose a value which gives a good compromise between filtering and response speed.

**For reasonably clean signals, a Filter Jump value of around 10 or less will give a good compromise between filtering and response speed to step change inputs.**

!! This feature is available in Advanced Mode only !!

- 1

Set1  
Digit
Set2  
Max/Min
Output  
Reset
Alarms  
OK

  
 Press 3 seconds

**Lockout Switch must be OFF**

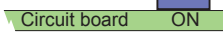

- 2

Set1  
Digit
Set2  
Max/Min
Output  
Reset
Alarms  
OK





Press repeatedly until you see **FiL.J.XX** where **XX** is the Filter Jump percentage  
(Default = **FiL.J.09**)
- 3

Set1  
Digit
Set2  
Max/Min
Output  
Reset
Alarms  
OK

You can set from **00** to **99**. Use the DIGIT and UP or DOWN button to increase or decrease this value.
- 4

Set1  
Digit
Set2  
Max/Min
Output  
Reset
Alarms  
OK





**Done!**

Press repeatedly to accept and return to display

### 3.18 LAST DIGIT ROUNDING UP BY 1, 2, 5, 10, 20 OR 50

You can adjust the way the display rounds up, which is useful if you want to display a very large number, but do not want jitter on the last digit. The display can be set to round up to the nearest 1 (no rounding) 2, 5, 10, 20 or 50

This feature is available in Easy and Advanced Modes

1

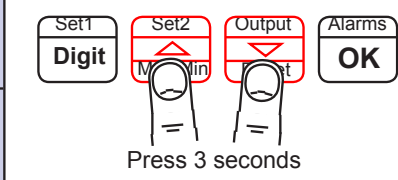

Press 3 seconds

**Lockout Switch must be OFF**



Circuit board ON

2

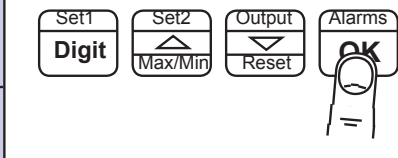

Press repeatedly until you see **LSt X** where X is either 1,2,5,10,20 or 50  
(Default = LSt 1))

3

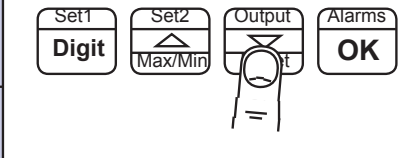

Press repeatedly to change the LST value to the one you want

4

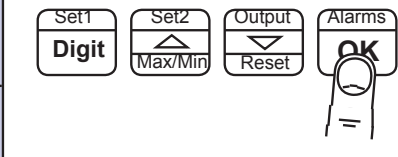



Done!

### 3.19 SCALE FACTOR ADJUSTMENT

After you have calibrated your meter, you can use the SCALE feature to make fine adjustments to calibration, without affecting the calibration itself. Examples

#### 1.Changing weight units of measure from kg to pounds

You could also use the SCALE to convert your readout from kg to pounds, without affecting the calibration. Simply set SCALE = 2.205 and your meter which was calibrated in kg will now read in pounds.

#### 2.Correcting for gravitational variance

Your weighing system was calibrated where gravitational acceleration = 9.802m/s<sup>2</sup> (New York City) You then move the system to Zurich where gravitational acceleration is reduced to 9.807m/s<sup>2</sup>

You can correct for this difference by setting Scale = 9.802 / 9.807 = 0.999, so that a given mass in Zurich will show the same weight as it did in New York City. Set Offset = 0.0000.

See [http://en.wikipedia.org/wiki/Earth%27s\\_gravity](http://en.wikipedia.org/wiki/Earth%27s_gravity)

!! This feature is available in Advanced Mode only !!

- 1

Set1  
Digit
Set2  
Max/Min
Output  
Reset
Alarms  
OK



Press 3 seconds

**Lockout Switch must be OFF**

 OFF  
ON
- 2

Set1  
Digit
Set2  
Max/Min
Output  
Reset
Alarms  
OK



Press repeatedly until you see **SCALE**, followed by the existing scale factor. (Default = **001.000**)
- 3

Set1  
Digit
Set2  
Max/Min
Output  
Reset
Alarms  
OK

Use DIGIT button to select each digit in turn, UP or DOWN buttons to increase or decrease each digit's value. Press OK when done.
- 4

Set1  
Digit
Set2  
Max/Min
Output  
Reset
Alarms  
OK



Press to accept

 **Done!**

### 3.20 OFFSET ADJUSTMENT

After you have calibrated your meter, you can use the OFFSET feature to make fine additions or subtractions to the reading, without affecting the calibration itself. For example if your weighing structure is altered after calibration and you want to subtract the effect of 37kg of extra metalwork which was welded to the hopper, you can easily do this by entering a value of -37 in the offset value.

!! This feature is available in Advanced Mode only !!

1

Set1  
Digit

Set2  
Max/Min

Output  
Reset

Alarms  
OK

Lockout Switch must be OFF



Circuit board ON

Press 3 seconds

2

Set1  
Digit

Set2  
Max/Min

Output  
Reset

Alarms  
OK

Press repeatedly until you see **OFFSet**, followed by the existing offset value. (Default is **000.000**)

3

Set1  
Digit

Set2  
Max/Min

Output  
Reset

Alarms  
OK

Use DIGIT button to select each digit in turn, UP or DOWN buttons to increase or decrease each digit's value. If you want to set a negative value, use DIGIT to select the left hand digit, and press the down button to go below 0 to activate the - sign. Press OK when done.

4

Set1  
Digit

Set2  
Max/Min

Output  
Reset

Alarms  
OK

Press to accept

✓

**Done!**

You may want to adjust a SCALE FACTOR value also, without affecting calibration. See the separate SCALE page for this feature.

30

### 3.21 MENU TIMEOUT ADJUSTMENT

The display has a default timeout of 60 seconds, to allow you sufficient time to refer to the manual between key operations. You can make this period shorter, if you wish, once you become more familiar with the setup method.

**1** **!! This feature is available in Advanced Mode only !!**

Set1 Digit Set2 Max/Min Output Alarms

Press together, briefly

Lockout Switch must be OFF

Circuit board ON OFF

**2**

Set1 Digit Set2 Max/Min Output Reset Alarms OK

Press repeatedly until you see **dLAY. XX** where **XX** is the delay in seconds. Choices are ...

dLAy.1 0  
dLAy. 20  
dLAy. 30  
dLAy. 60 (default)

**3**

Set1 Digit Set2 Max/Min Output Alarms OK

Press DOWN or UP button briefly and repeatedly to choose from **dlay.10** or **dlay.20** or **dlay.30** or **dlay.60**

Press briefly to toggle

**4**

Set1 Digit Set2 Max/Min Output Reset Alarms OK

Press to accept

Done!

### 3.22 REVERSE DISPLAY FUNCTION (MIRROR IMAGE)

If you need to be able to see a reflection of the display in a mirror or other reflective surface, for example in a simple heads-up system, or for drivers reversing into a bay, using mirrors only, you can set the display to show as a mirror image.

!! This feature is available in Advanced Mode only !!

**1**

Set1  
Digit

Set2  
Max/Min

Output  
=

Alarms  
=

Lockout Switch must be OFF

OFF

|

ON

Press together, briefly

**2**

Set1  
Digit

Set2  
Max/Min

Output  
Reset

Alarms  
OK

Press OK button briefly and repeatedly until you see

rEV.d 0 (Default)  
or  
rEV.d 1

**3**

Set1  
Digit

Set2  
Max/Min

Output  
=

Alarms  
OK

Press DOWN or UP button briefly and repeatedly to choose from

rEV.d 0 (normal display) or  
rEV.d 1 (mirror image display)

Press briefly to toggle

**4**

Set1  
Digit

Set2  
Max/Min

Output  
Reset

Alarms  
OK

✓

**Done!**

Press to accept

rEV.d 0



Example of normal display format

rEV.d



Example of Mirror Reverse display

### 3.23 BOOTUP ROUTINE CHOICES

When you switch on your meter, it can be set to power up with 3 possible summary message combinations. The choices are:- boot 0 = Segment test, followed by a full summary of software revision, calibration audit number, model number, installed options.

boot 1 = Segment test followed by model number (Default)

boot 2 = No summary, meter displays the measurement value immediately power is applied.

boot 3 = Segment test remains permanently enabled until any button is pressed

!! This feature is available in Advanced Mode only !!

- 1

Set1 Digit	Set2 Max/Min	Output Reset	Alarms OK
---------------	-----------------	-----------------	--------------

Press 3 seconds

Lockout Switch must be OFF



Circuit board ON
- 2

Set1 Digit	Set2 Max/Min	Output Reset	Alarms OK
---------------	-----------------	-----------------	--------------

Press repeatedly until you see **SCALE**, followed by the existing scale factor. (Default = **001.000**)
- 3

Set1 Digit	Set2 Max/Min	Output Reset	Alarms OK
---------------	-----------------	-----------------	--------------

Use DIGIT button to select each digit in turn, UP or DOWN buttons to increase or decrease each digit's value. Press OK when done.
- 4

Set1 Digit	Set2 Max/Min	Output Reset	Alarms OK
---------------	-----------------	-----------------	--------------

Press to accept



**Done!**

You can trigger the full summary message whenever you want, without having to power the meter off, by pressing and holding the 2 outer buttons (Set1 + Alarms) for more than 3 seconds.



### 3.24 ERROR CODES AND FAULT FINDING

**--Ur--** 1. Under Range. The meter is being asked to display a value which is more negative than its limit of -199999.

**--Or--** 2. Over Range. The meter is being asked to display a value which is higher than its limit of 999999

These fault codes could be displayed because the signal is too negative, too positive, or because there is a wiring error, or because the display's scaling has been adjusted to give excessive sensitivity, or because there is a fault in the display.

a. If you are connecting a 4-20mA signal to the display, please measure the DC millivolt signal between terminals 2(-) and 3(+). Ideally, you will measure 132mV at 4mA and 660mV at 20mA. If the voltage is much higher, there may be a problem with the 33 Ohm input shunt resistor.

You can verify this as follows...

Remove the input signal and power connectors to the meter, and measure the resistance between terminals 2 and 3. This should be 33 Ohms. If it is more than this, the resistor has probably been overloaded and burned by having a voltage connected across it. Please check your field wiring to ensure that no more than 30mA or 1V can be applied to the current input terminals.

Sometimes excessive current can feed to the current input of the display if your 2 wire 4-20mA transmitter is faulty or is wired incorrectly, because we rely on the transmitter to regulate the loop current between 4 and 20mA. The excitation power supply for the loop may have a much higher capacity than 20mA.

b. If the measurements above were satisfactory, the problem may be caused by the scaling being too sensitive. If you are happy to do so, it is a simple matter to reset the display's scaling to the factory default conditions.

**Put the lockout switch off** and press all 4 buttons together for around 3 seconds until the display shows "dEFS n".

Then press the UP button once so the display shows "dEFS Y".

Now press the OK button and the display will be reset to factory defaults.

If still no success, please return the display to us for the attention of our QA Manager, with a report of what you found, for repair.

---

## 4. Option boards

---

### 4.1 HOW TO INSTALL OPTION BOARDS



---

CAUTION WHERE THE PRODUCT IS INTENDED FOR “UL” INSTALLATIONS REMOVAL OR ADDITION OF OPTION BOARDS IS NOT PERMITTED.

---



---

**WARNING! DISCONNECT POWER BEFORE YOU EXPOSE THE INTERNALS OF THE DISPLAY**

---

If you want to open your display to install or modify option boards, follow these steps...

- 1) Switch off power to the display and unplug all connectors.
- 2) Undo all the thumb screws on the rear case, store them safely and remove the back panel
- 3) Locate the main option board, which will be similar in appearance to the diagram below.

If a main option board is absent, which will be the case if the display was ordered without any output options, then a main option board will need to be fitted. The board assemblies will look like this...

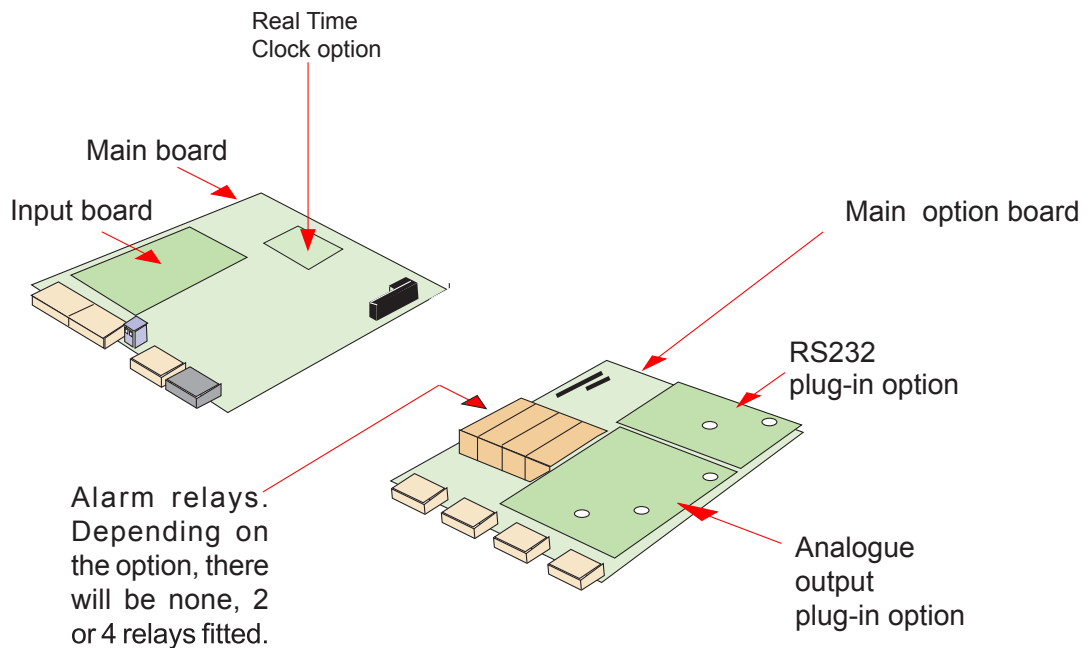

The analogue output and RS232 plug-in option boards are fixed to the main option board with white plastic pillars. You must apply a firm force when fitting or removing these options. Always be careful to connect the pins to sockets accurately. When reassembling, make sure the option boards are firmly attached to the motherboard above.

---

## Appendix A :

---

### WASTE ELECTRICAL ELECTRONIC EQUIPMENT (WEEE)

In Europe, this equipment must be disposed of in accordance with European Parliamentary Directive 2002/96/EC. This directive encourages recycling and the reduction of waste materials in the environment. This means it must be sent to an approved recycling plant if you want to dispose of it. It must not be thrown away with general rubbish.

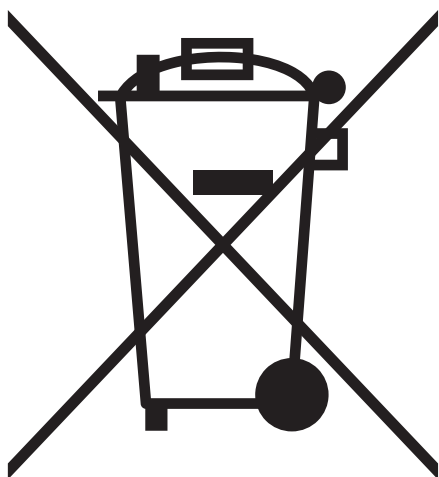

### WEEE - WASTE RECYCLING



---

If you are unable to dispose of this item locally, you may send it to us for recycling.

---

#### Conditions:

1. We will only accept items of our manufacture.
2. You must pay for the transport of the goods to us.
3. We will only accept items if they include a signed declaration by an authorised person in your organisation, stating that :-
  - i. The item is safe to handle and has no contaminants which may be harmful to health.
  - ii. You wish us to dispose of or destroy the item(s)



*Test, Mesure et Contrôle des Couple-Vitesse-Puissance • Charge-Force-Poids • Tension • Déplacement*

[www.magtrol.com](http://www.magtrol.com)

**MAGTROL SA**

Route de Montena 77  
1728 Rossens/Fribourg, Suisse  
Tél: +41 (0)26 407 3000  
Fax: +41 (0)26 407 3001  
E-mail: [magtrol@magtrol.ch](mailto:magtrol@magtrol.ch)

**MAGTROL INC**

70 Gardenville Parkway  
Buffalo, New York 14224 USA  
Tél: +1 716 668 5555  
Fax: +1 716 668 8705  
E-mail: [magtrol@magtrol.com](mailto:magtrol@magtrol.com)

**Subsidiaries in:**

Germany • France  
China • India

Worldwide Network  
of Sales Agents

