

INSTRUCTION MANUAL

SIGNAL CONVERTER I/V AND I/I CST 113

P/N 623.005 E

(MACST113-01/E)



Copyright © Magtrol SA, 1997

All rights reserved

Published and printed by Magtrol SA in Fribourg, Switzerland

The information contained in this document is subject to change without notice. This information shall not be used, duplicated or disclosed, in whole or in part, without the express written permission of Magtrol.

TABLE OF CONTENTS

	Purpose and Scope of this Manual	iii
	Who should use this Manual ?	iii
	Manual Organization	iv
	Related Publications	iv
1	SAFETY	1
1.1	Symbols Used in This Manual	1
1.2	Important Remarks on Safety	2
1.2.1	Location of Safety Symbols in This Manual	2
1.3	Additional Remarks on Safety	2
2	INTRODUCTION	3
3	MOUNTING	7
3.1	General remarks	7
3.2	Mounting of the CST 113 with plastic housing	7
3.3	Mounting of the CST 113 with aluminium housing	8
4	CONNECTION	11
4.1	General remarks	11
4.2	Opening of the CST 113 plastic housing	11
4.3	CST 113 with plastic housing, PG 11 stuffing gland	11
4.4	Electrical connections	13
4.4.1	Connection of a DI series displacement transducer	13
4.4.2	Connection of a 4 to 20 mA current source with independent supply	14
4.4.3	Connection of a 4 to 20 mA two-wire current source	16
5	CALIBRATION	18
5.1	Choice of the mechanical configuration	18
5.1.1	Measurement tube completely inserted corresponding to the reference 0	18
5.1.2	Measurement tube pulled out corresponding to the reference 0	19

5.2	Micro-switch configuration for a voltage output	19
5.2.1	Voltage output with a DI transducer	20
5.2.2	Voltage output with 4 to 20 mA input current source	22
5.3	Micro-switch configuration for a current output	22
5.3.1	Current output with a DI transducer	23
5.3.2	Current output with 4 to 20 mA input current source	24
5.4	Adjusting the mechanical zero point	24
5.5	Offset adjustment	25
5.6	Precise adjustment of the gain	26
5.7	CST 113 configuration in a single stroke	27
5.8	Micro-switch and potentiometer functions	28
5.9	Transmission OK	29
A	CONNECTION CABLES	30

PREFACE

Purpose and Scope of this Manual

This manual provides reference information for the CST 113 signal converter. It provides information concerning the installation, the connection and the calibration of the unit.

Who should use this Manual ?

This manual is written for users who want to install the CST 113 signal converter on test benches, connect and calibrate it.

It is assumed that the operator has the necessary technical training in electrical engineering (professional certificate/diploma, or equivalent) to enable him to carry out the above mentioned operations.

Manual Organization

This section gives an overview of the structure of the manual and the information contained within it. Some information has been deliberately repeated in different sections of the document to minimize cross-referencing and to facilitate understanding through reiteration.

The chapters of this manual are presented in logical order. You should read those that are most relevant to you and then keep the manual at hand for future reference.

The structure of the manual is as follows :

Chapter 1 : **Safety** - Contains important information for your personal safety and the correct use of the unit.

THIS CHAPTER SHOULD BE READ BEFORE ATTEMPTING TO INSTALL OR USE THE SIGNAL CONVERTER.

Chapter 2 : **Introduction** - Contains the CST 113 data sheet, which describes the unit and gives its technical specifications.

Chapter 3 : **Mounting** - Contains instructions concerning the mounting of the signal converter.

Chapter 4 : **Connection** - Contains instructions concerning the connection of the signal converter.

Chapter 5 : **Calibration** - Contains a description of the signal converter calibration process.

Appendix A : **Connection cables** - Contains drawings concerning the connection cables used for the signal converter.

Product Defect Report - Allows the user to indicate problems observed on a module/system, thus enabling our After-Sales Service department to repair the unit as quickly as possible.

Documentation Evaluation Form - Allows the user to provide us with valuable feedback on our documentation.

Related Publications

For additional information relating to the use of the CST 113 signal converter the operator is referred to the following documents and publications :

- Instruction Manual DI 505 ÷ 516 P/N 622.008

1 SAFETY

1.1 Symbols Used in This Manual

The following symbols and type styles may be used in this manual to highlight certain parts of the text :



The **NOTE** symbol. 

*This is intended to draw the operator's attention to complementary information or advice relating to the subject being treated.
It introduces information enabling the correct and optimal functioning of the product to be obtained.*



The **CAUTION** safety symbol. 

This is used to draw the operator's attention to information, directives, procedures, etc. which, if ignored, may result in damage being caused to the material being used.

The associated text describes the necessary precautions to take and the consequences that may arise if the precautions are ignored.



THE **WARNING** SAFETY SYMBOL. 

THIS INTRODUCES DIRECTIVES, PROCEDURES, PRECAUTIONARY MEASURES, ETC. WHICH MUST BE EXECUTED OR FOLLOWED WITH UTMOST CARE AND ATTENTION, OTHERWISE THE PERSONAL SAFETY OF THE OPERATOR OR THIRD PARTIES MAY BE PUT AT RISK.

THE READER MUST ABSOLUTELY TAKE NOTE OF THE ACCOMPANYING TEXT, AND ACT UPON IT, BEFORE PROCEEDING FURTHER.

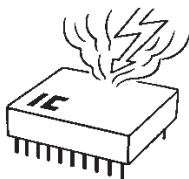

The **ELECTROSTATIC SENSITIVE DEVICE** symbol. 

This indicates that the device or system being handled may be damaged by electrostatic discharges unless adequate precautions are taken.

The operator should wear a well-earthed wristband when handling such devices. They should be transported and stored in specially designed anti-static bags.

1.2 Important Remarks on Safety

CAUTION



This instruction manual should be read carefully and the safety instructions observed before installing, calibrating or using the material described herein.

1.2.1 Location of Safety Symbols in This Manual

The operator should also take note of the safety-related information found elsewhere in this manual :



This symbol is found on the following pages :
1-2 ; 3-1 ; 4-2



This symbol is found on the following pages :
4-1 ; 5-1



This symbol does not appear in the manual

1.3 Additional Remarks on Safety



For the correct and safe use of this instrument, it is essential that both operating and servicing personnel follow generally accepted safety procedures in addition to safety precautions specified in this manual. Specific warning and caution statements, where they apply, will be found throughout the manual. These are highlighted by the corresponding warning and caution symbols (described above).

The safety procedures should be communicated to all personnel who are liable to operate the equipment described in this manual.

No modifications, transformations or repairs should be made to the equipment without having first obtained the written permission of Magtrol. Failure to observe this will invalidate the warranty.

2 INTRODUCTION



CST 113
Data Sheet

CST 113

Signal Converter I/U and I/I

FEATURES

- Signal converter to be used with Magtrol DI Series Contactless Displacement Transducers as well as with LE Series Load Measuring Pins
- Wide number of possibilities to select functions (polarity) and signal ranges (offset and gain)
- Fast calibration in one displacement, with independent settings
- Transducer supply current up to 80 mA
- Outputs: 0 to ± 10 VDC, 0 to 20 mA (4 to 20 mA) or ± 10 to 0 VDC, 20 to 0 mA (20 to 4 mA)
- Available with either a plastic housing, for mounting on a DIN rail, or housed in aluminum IP 65



DESCRIPTION

The CST 113 is a signal converter for transducers delivering a signal of 4 to 20 mA. The converter output can be chosen as follows: a voltage-based signal (I/U conversion) or a current-based signal (I/I), either with signal inversion if required. A wide variety of offset and gain values can be selected, matching many different applications. The use of micro switches (DIP switches) and potentiometers enable easy on-site adjustments and the independent settings make it possible to calibrate the CST 113 in one displacement, from the minimal to the maximum position of the jack.

A “transmission OK” output enables the electrical connection between the DI transducer and the CST 113 Converter to be

checked, thus allowing the system to be used in applications where safety is important. This operation is simply carried out by measuring the current coming from the DI transducer. An anomaly is indicated by the opening of the output transistor.

The CST 113 power supply input features a galvanic separation to electrically isolate the power supply ground from the measuring chain ground. The CST 113 circuitry is located in a plastic housing which can be mounted on a DIN EN 20022 - EN 50035 rail or fixed in an aluminium housing.

SYSTEM CONFIGURATION

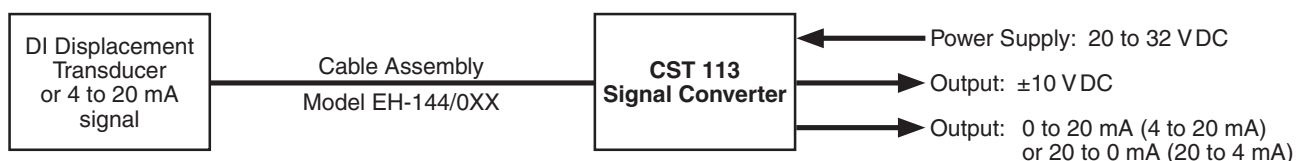

Block Diagram

CST 113

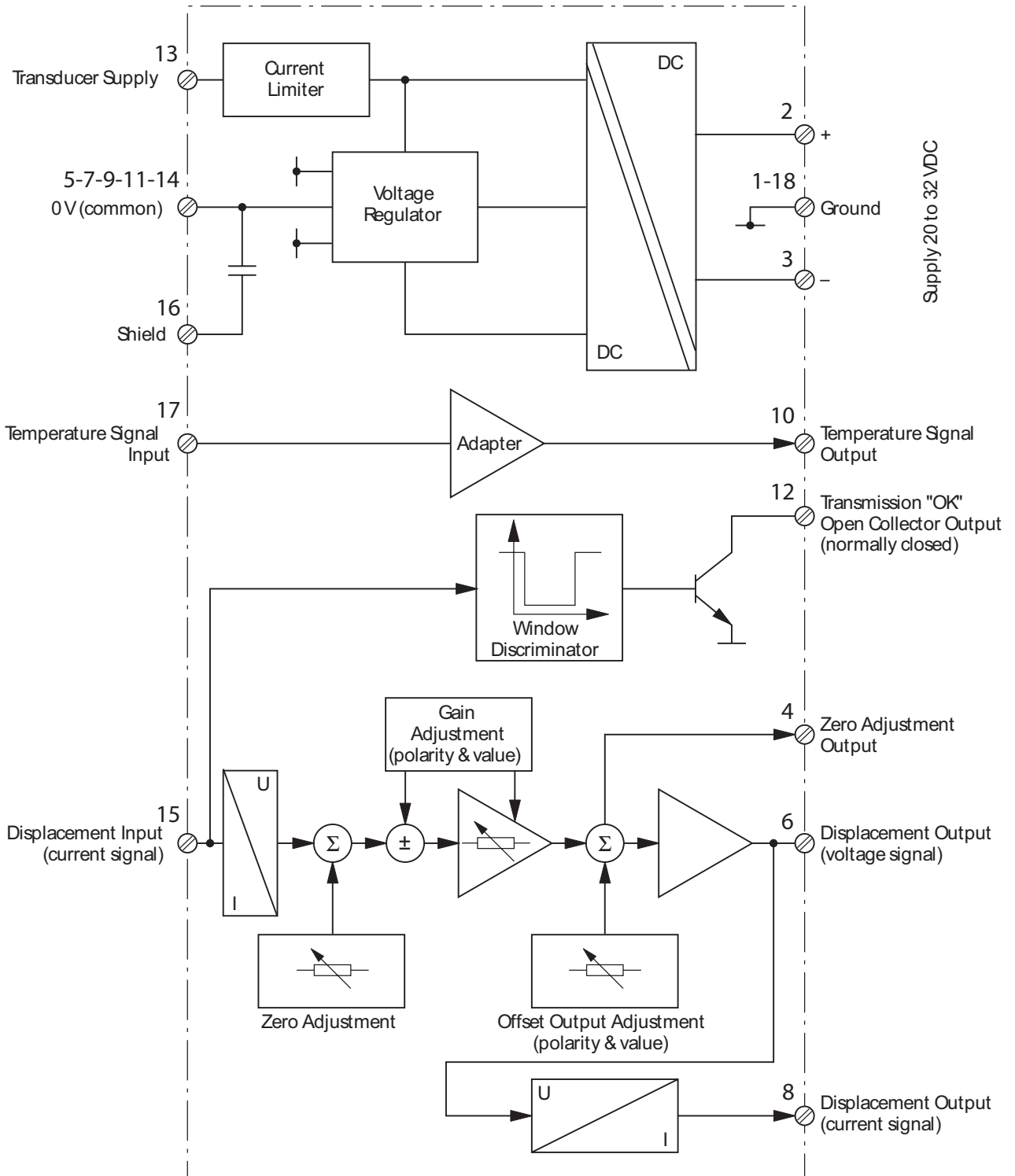

f Specifications

CST 113

CONVERTER SUPPLY	
Voltage	20 to 32 VDC (galvanic separation between supply input and circuit)
Current	< 200 mA
TRANSDUCER SUPPLY	
Voltage	24 V ±1 V
Current	80 mA max.
INPUT SIGNALS	
Displacement Signal	4 to 20 mA nominal 2 to 22 mA max.
Temperature Signal	0 to 10 VDC
OUTPUT SIGNALS	
Displacement Voltage Signal	±10 VDC
<ul style="list-style-type: none"> • Working Range • Output Resistance • Maximum Current • Setting range of Offset Voltage (output) • Setting Range of Transfer (gain) • Thermal Stability Between 0 and +55°C 	100 Ω 2 mA -10 to +10 VDC +0.26 V/mA to +3.12 V/mA or -0.26 V/mA to -3.12 V/mA 150 ppm/°C typical
Displacement Current Signal	0 to 20 mA (4 to 20 mA) or 20 to 0 mA (20 to 4 mA)
<ul style="list-style-type: none"> • Working Range • Type • Maximum load • Setting Range of Offset Current (output) • Setting Range of Transfer (gain) • Thermal Stability Between 0 and +55°C 	single pole current source ≤ 500 Ω 0 to 20 mA +0.52 mA/mA to +6.24 mA/mA or -0.52 mA/mA to -6.24 mA/mA 150 ppm/°C typical
Temperature Signal	±10 VDC
<ul style="list-style-type: none"> • Working Range • Output Resistance • Maximum Current • Transfer 	100 Ω 2 mA 100 mV/°C (2 VDC ≡ 20 °C)
Transmission OK	Open collector (20 mA max.)
ENVIRONMENT	
Plastic Housing	0 to +55 °C
<ul style="list-style-type: none"> • Operating Temperature • Storage Temperature • Humidity • Vibration and Shock • EMC 	-20 to +70 °C Max. 95% without condensation 2 g / 10 to 55 Hz According to EN-50081-2 (Generic Emission Standard) and EN-50082-2 (Generic Immunity Standard)
Aluminum Housing	-40 to +80 °C
<ul style="list-style-type: none"> • Operating Temperature • Storage Temperature • Humidity • Vibration and Shock • EMC 	-45 to +85 °C IP 65 According to IEC 68.2 According to EN-58081-2 (Generic Emission Standard) and EN-58082-2 (Generic Immunity Standard)
MECHANICAL CHARACTERISTICS	
Plastic Housing	≈ 0.2 kg / ≈ 0.441 lb
<ul style="list-style-type: none"> • Weight 	
Aluminum Housing	A123
<ul style="list-style-type: none"> • Type • Stuffing Glands • Weight 	3 × PG 11 ≈ 2 kg / ≈ 4.41 lb

Dimensions & Ordering Information

CST 113

DIMENSIONS

Plastic Housing (CST 113 / 011)

For mounting on a DIN rail

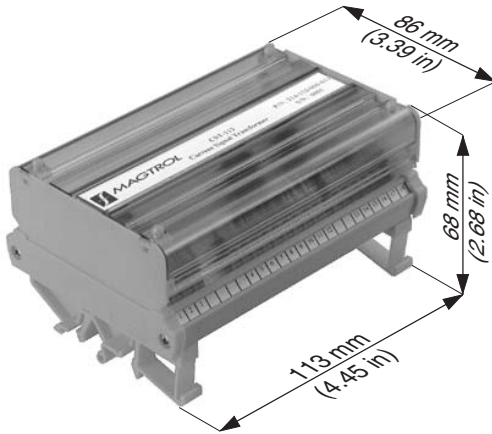

Aluminum Housing (CST 113 / 021)

Aluminum IP 65

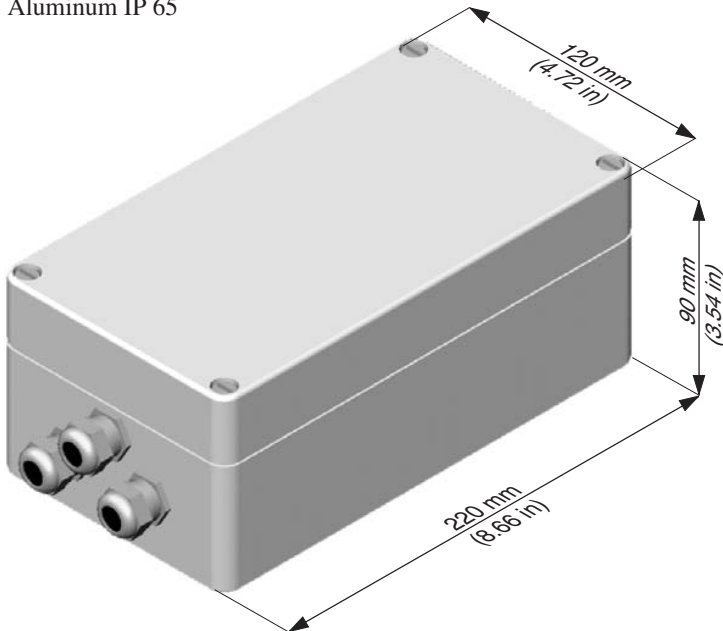

ORDERING INFORMATION

PART NUMBER	MODEL	DESCRIPTION
214-113-000-011	CST 113 / 011	Signal Converter I/U and I/I with plastic housing
214-113-000-021	CST 113 / 021	Signal Converter I/U and I/I with aluminum IP 65 housing

Accessory Ordering Information

CABLE	Part Number
4-Core Connection Cable	
• Radox K-414	957.37.22.2666

MATING PLUG (5-pole)	Part Number
• Straight	957.11.08.0122
• Right-Angle (90°)	957.11.08.0132

CONNECTION CABLE ASSEMBLY (K-414 cable with 5-pole mating plug)

Part Number: EH 14 / 0 1

Mating Plug	
• Straight	4
• Right-Angle (90°)	5

Cable Length	
• 3 m	1
• 5 m	2
• 10 m	3

DISPLAYS AND INDICATORS (On request)

Due to the continual development of our products, we reserve the right to modify specifications without forewarning.

3 MOUNTING

3.1 General remarks

The CST 113 may be supplied in two different housings, one in plastic, the other in aluminium. The plastic housing is to be mounted on a rail, the aluminium housing must be fixed by means of 4 screws.

3.2 Mounting of the CST 113 with plastic housing

The CST 113 with plastic housing is equipped with attachments for the rails according to DIN EN 50022 and DIN EN 50035. Figure 3-1 shows how to fix this housing onto the rail.



The CST 113 plastic housing is not watertight and must therefore be protected from water and dust. It should be ideally put into a switch cabinet.

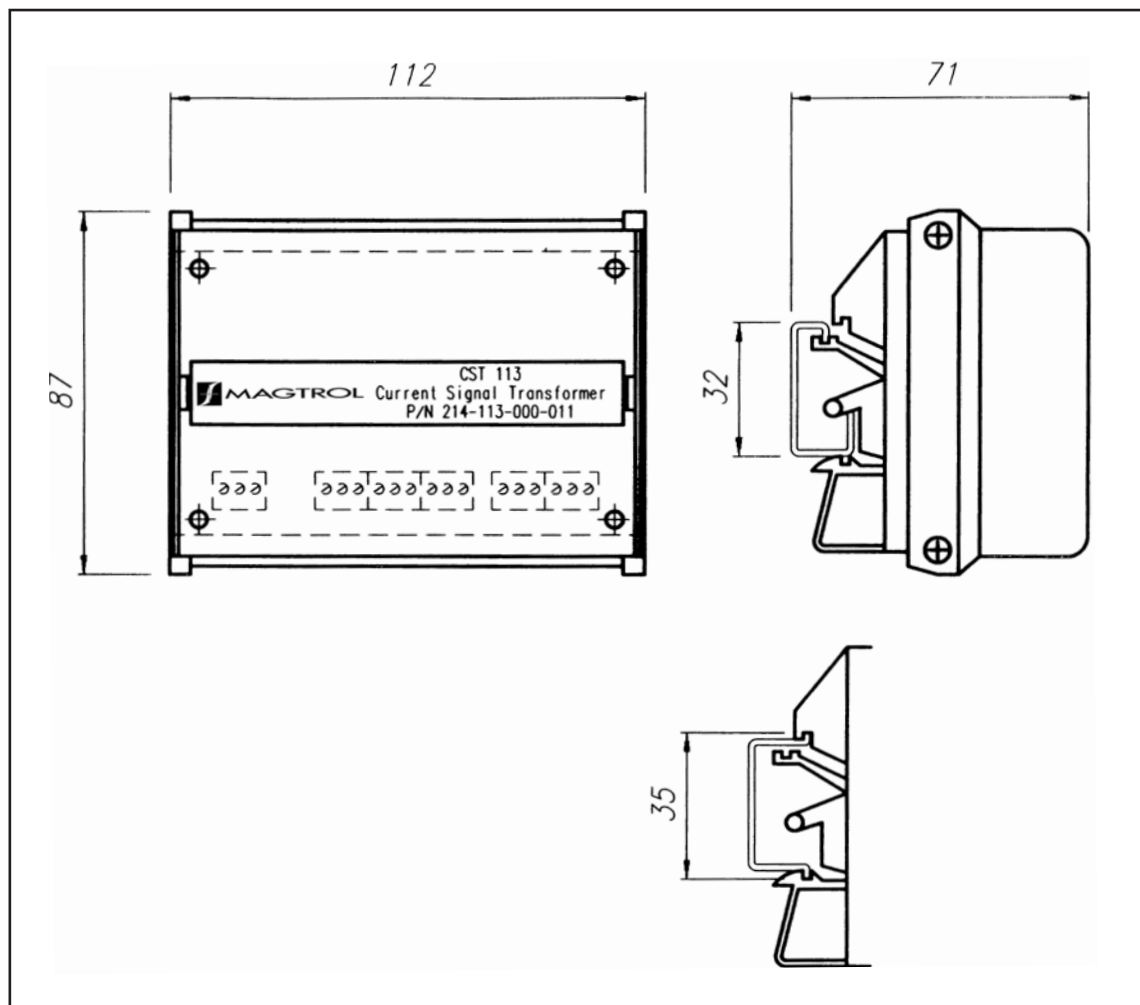

Fig. 3-1 : Fixing of the CST 113 with plastic housing

3.3 Mounting of the CST 113 with aluminium housing



Make sure that the temperature of the area in which the CST 113 operates lies between -40 °C and +80 °C.

- Chose a mounting place free of vibrations (for instance an instrument base)
- Trace the position of the 4 screw threads on the mounting surface (refer to figure 3-2)
- Drill and thread the 4 M6 holes. The threads must be approximately 15 mm deep.
- Remove the signal converter cover by loosening its 4 screws (refer to figure 3-2).
- Position the housing on the mounting surface and fix it by means of the 4 M6 x 30 screws. The fastening torque must be adapted to the screw type used.
- Connect and calibrate the signal converter as described in chapter 4 and 5.
- Place the cover back on the signal converter and tighten its four screws.

The installation of the CST 113 is now finished.

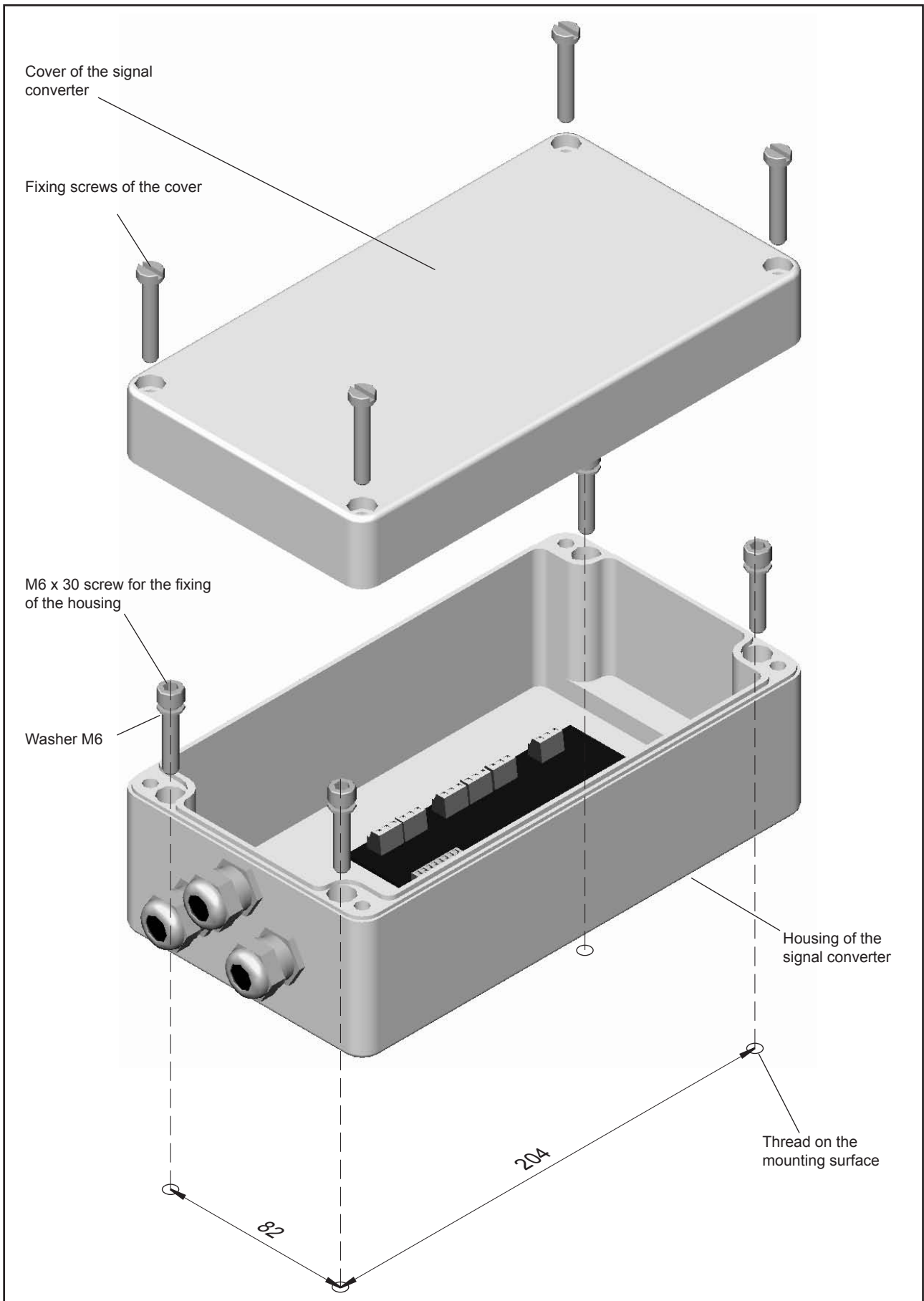

Fig. 3-2 : Fixing of the CST 113 with aluminium housing

4 CONNECTION

4.1 General remarks

This chapter describes methods of connecting CST 113 signal converters to 4 to 20 mA outputs, specially to DI series displacement transducers.



Electrostatic discharges may seriously damage the CST signal converter. All adequate preventive measures must therefore be taken by the user.

4.2 Opening of the CST 113 plastic housing

If the housing is fixed on the rail (see chapter 3), it may be opened for carrying out the necessary connections as described with the following figure :

- 1) Spread the orange side caps in order to free the pins of the transparent cover.
- 2) Press on the edges of the transparent cover and lift it vertically.

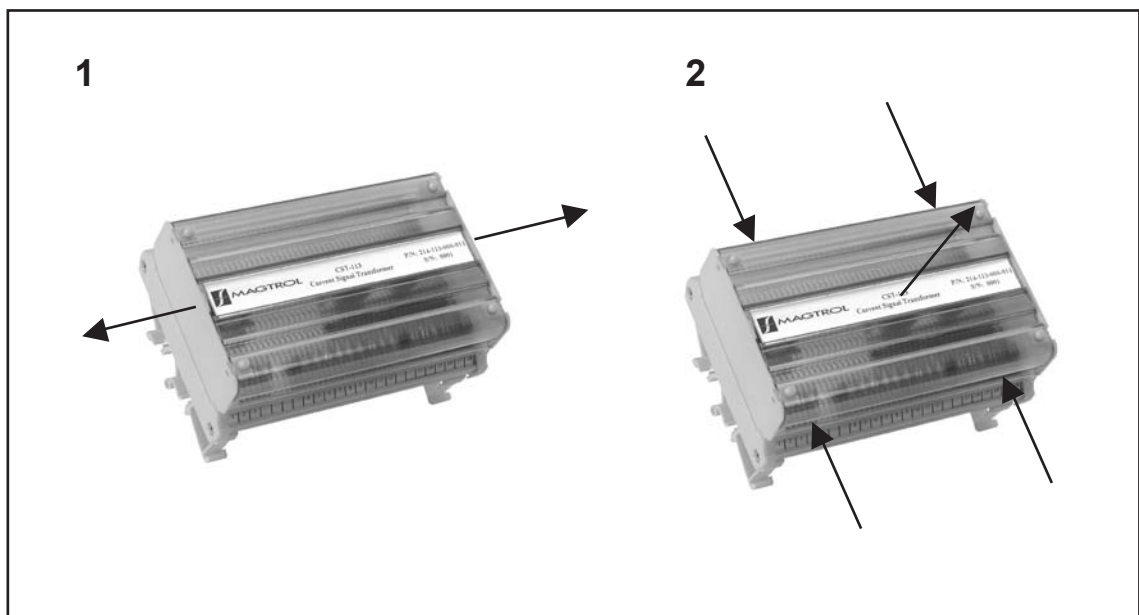

Fig. 4-1 : Opening the CST 113 with plastic housing

4.3 CST 113 with plastic housing, PG 11 stuffing gland

Once the aluminium housing is fixed according to Chapter 3 it can be opened. The electric cables have to be passed through the stuffing glands as described hereafter :

The stuffing glands allow cables to pass through the wall of the housing of the signal converter while providing the sealing of the housing and holding the cables. To pass the cables into the stuffing gland proceed as follows :

- Strip the conductors from the various cables if this has not already been done.
- Take off the cover of the supply unit housing by unscrewing its 4 screws.

- Pass the cables into the stuffing gland proceeding as follows (refer to figure 4-2):
 - Unscrew element 1 in an anticlockwise direction. Element 5 should not be removed from the housing.
 - Take out seal 2 and 3 of element 1 (the elements 2 and 3 allow one to adapt the stuffing gland to the various cable diameters). Element 2 can now be removed from element 3 simply by pushing it outwards.
 - Pass the cables through the elements 1, 2 (if used), 3, 4 and 5.
 - Reassemble the stuffing gland elements and, before positioning element 1, coat seal 3 with silicon as shown on figure 4-2. Tighten element 1 so that it projects beyond joints 2 and/or 3 to provide the degree of sealing required.
 - Also make sure the cable is firmly held by the stuffing gland.



**Do not damage the seals with sharp-edged objects.
Check that no foreign bodies can slide between the elements of the stuffing gland.
Degrease the surface of the cables which will come into contact with the seal.**

The sealing of the stuffing gland cannot be guaranteed unless these instructions

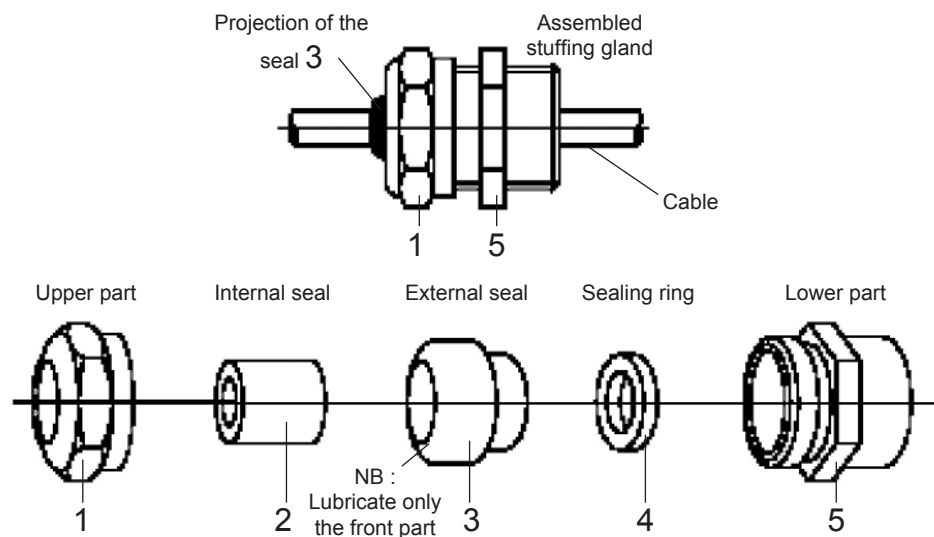

Fig. 4-2 : Stuffing gland (view of the assembly and exploded view).

are followed.

4.4 Electrical connections

4.4.1 Connection of a DI series displacement transducer

DI series transducers are connected to the CST 113 signal converter as described in the diagram

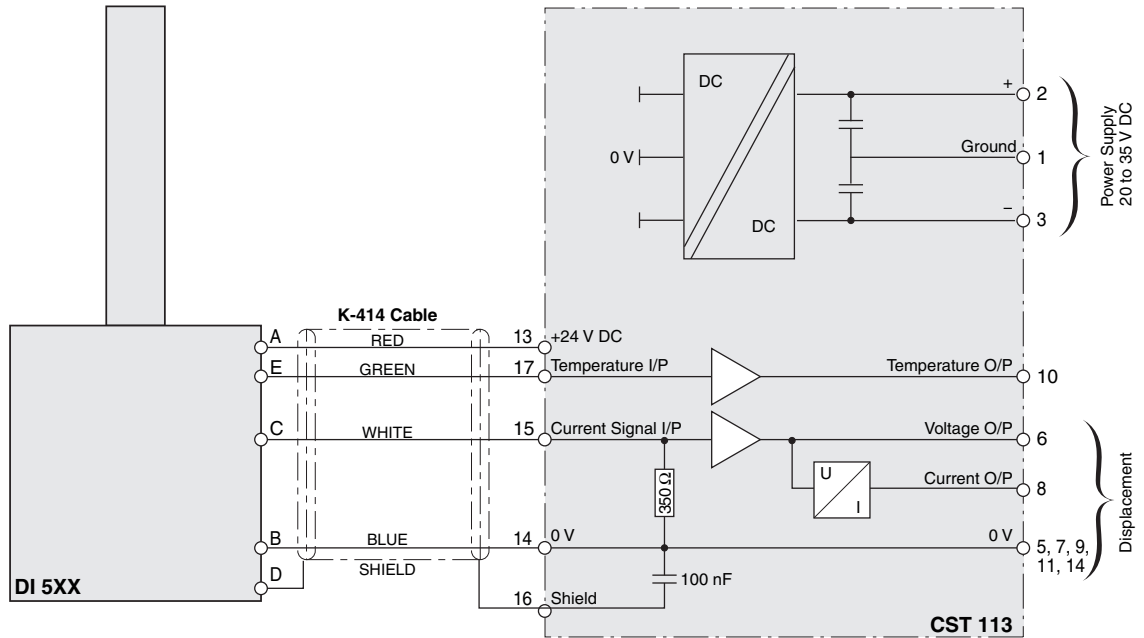

Fig. 4-3 : Connection of a DI transducer to the CST 113 signal converter

18	Case - GND
17	Temperature I/P
16	Shield
15	Current Signal I/P
14	0 V
13	Transducer Supply

12	OK O/P
11	0 V
10	Temperature O/P
9	0 V
8	Current O/P
7	0 V
6	Voltage O/P
5	0V
4	Zero O/P Adjust

3	0 V (Supply)
2	+24 V (Supply)
1	Case - GND

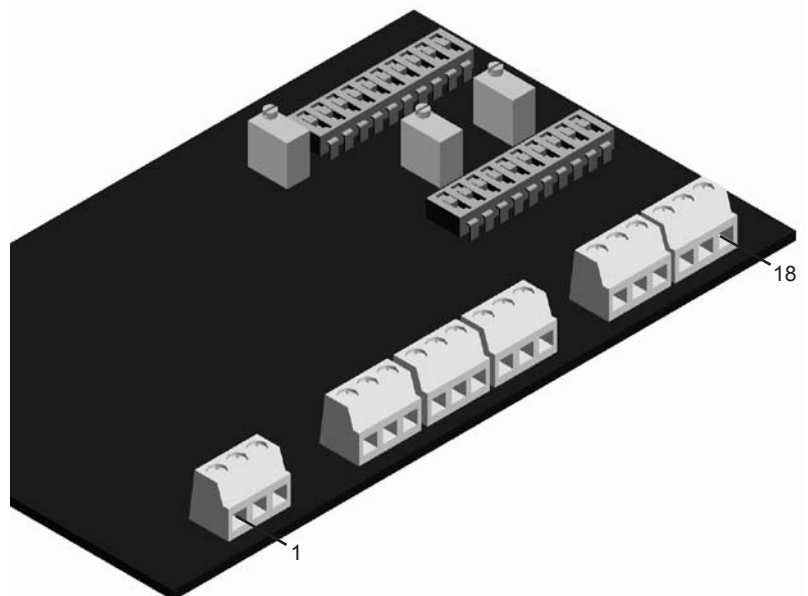

Fig. 4-4 : Connecting terminals.

in figure 4-3. The location of the circuit terminals is shown in figure 4-4.

4.4.2 Connection of a 4 to 20 mA current source with independent supply

Any 4 to 20 mA current source can be connected to the CST 113 signal converter. The signal to be processed must be put on terminal 15 (refer to figure 4-6 for the terminal locations).

A stabilised 24 V DC supply tension is available on the terminals 13 and 14. For more detailed information concerning the possible connections see figure 4-5 (CST 113 bloc diagram) and figure 4-6 for the terminal location on the circuit board.

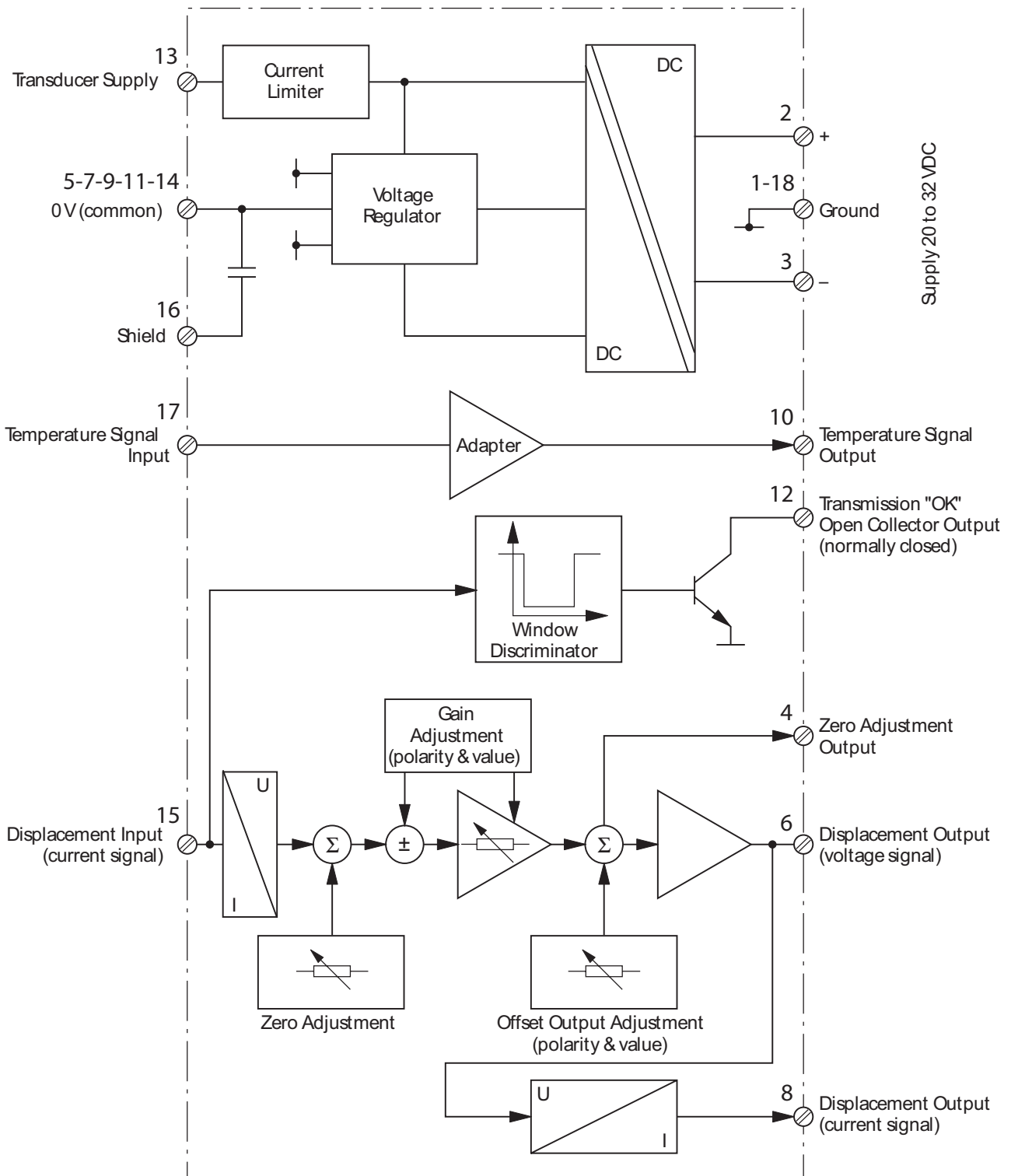

Fig. 4-5 : Block diagram

18	Case - GND
17	Temperature I/P
16	Shield
15	Current Signal I/P
14	0 V
13	Transducer Supply

12	OK O/P
11	0 V
10	Temperature O/P
9	0 V
8	Current O/P
7	0 V
6	Voltage O/P
5	0V
4	Zero O/P Adjust

3	0 V (Supply)
2	+24 V (Supply)
1	Case - GND

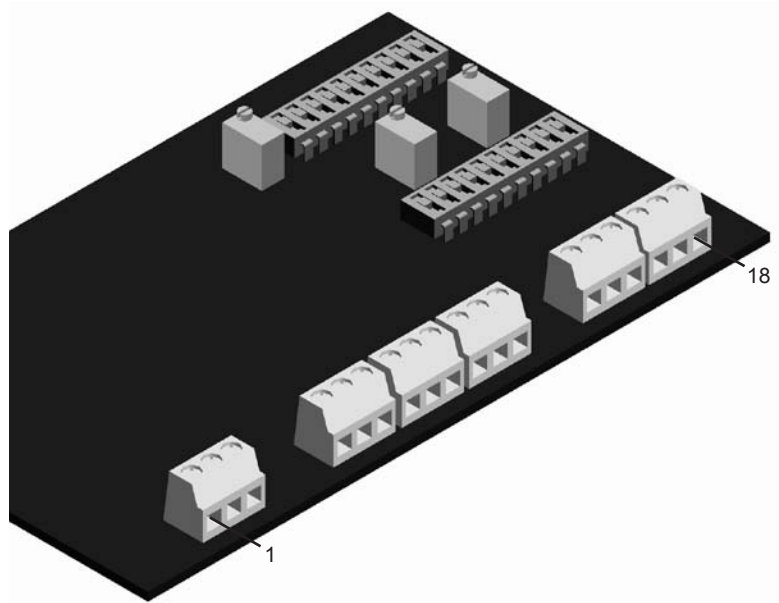

Fig. 4-6 : Connecting terminals.

4.4.3 Connection of a 4 to 20 mA two-wire current source

The connection of a 4 to 20 mA two-wire transducer, such as the Magtrol LE load measuring pin, is possible. The following procedure is given for the LE load measuring pin. For other transducers, refer to the corresponding instruction manual.



Most of the 4 to 20 mA transducers available on the market can be run by the tension supplied by the CST 113 (24 V). It is however important to check that the transducer does not require a minimum voltage exceeding 15 V.

The diagram in figure 4-7 shows how a 4 to 20 mA LE series transducer can be connected to an electronic unit. For the CST 113, the voltage U_a is $24\text{ V} \pm 1\text{ V}$ and the line resistance R_L is $\sim 350\ \Omega$. Figure 4-8 indicates the positions of the connecting terminals on the circuit board.

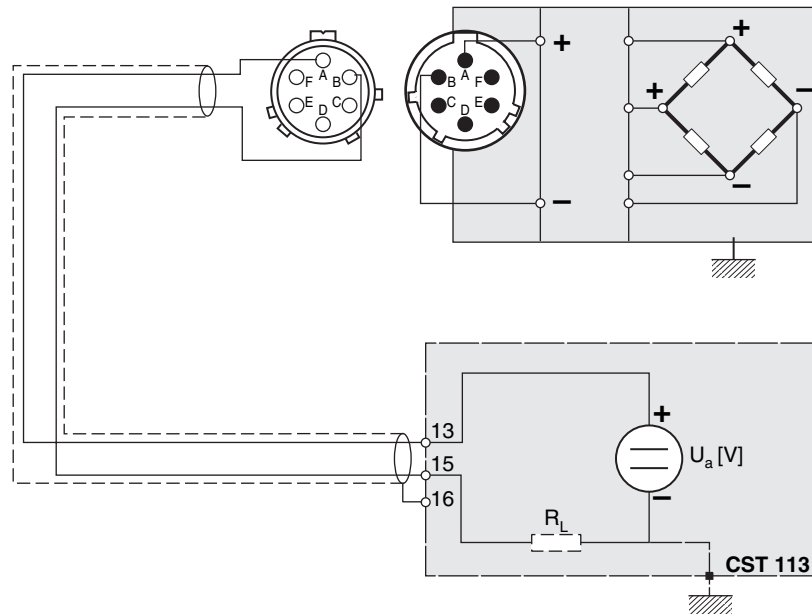

Fig. 4-7 : Connection diagram of a LE load measuring pin.

According to the diagram in figure 4-9, with the minimum voltage 23 V and the input resistance $\sim 350\ \Omega$, the working point is to be found in the operating range of the transducer.

18	Case - GND
17	Temperature I/P
16	Shield
15	Current Signal I/P
14	0 V
13	Transducer Supply
12	OK O/P
11	0 V
10	Temperature O/P
9	0 V
8	Current O/P
7	0 V
6	Voltage O/P
5	0V
4	Zero O/P Adjust
3	0 V (Supply)
2	+24 V (Supply)
1	Case - GND

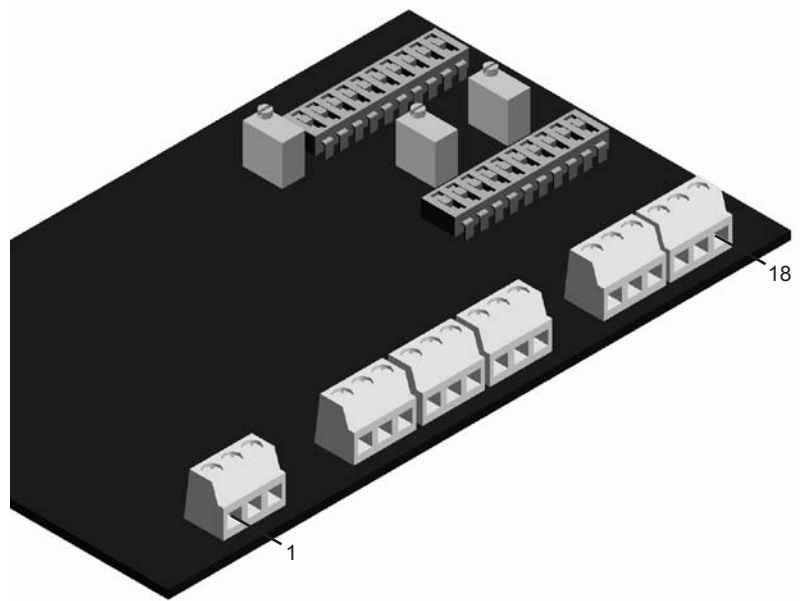

Fig. 4-8 : Connecting terminals.

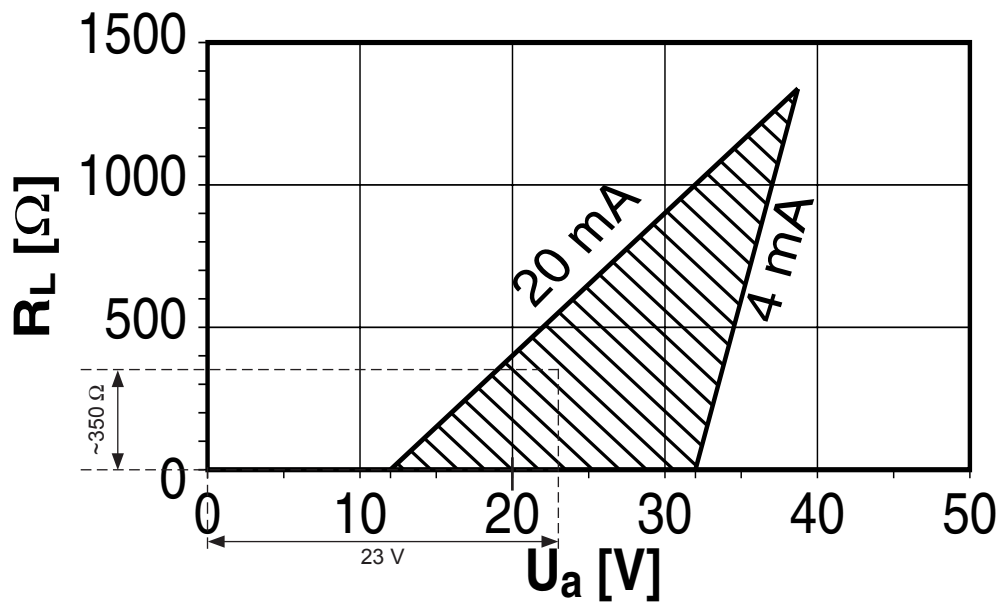

Fig. 4-9 : Operating range of the LE load measuring pin.

5 CALIBRATION



Electrostatic discharges may seriously damage the CST 113 signal converter. All adequate preventive measures must therefore be taken by the user.

5.1 Choice of the mechanical configuration

This section allows one to carry out the configuration of the CST 113 output, depending on the measurement tube displacement.

5.1.1 Measurement tube completely inserted corresponding to the reference 0

The figures 5-1 and 5-2 allow one to determine the micro-switch positions for a given customer application. Refer to figure 5-3 for the micro-switch location on the circuit board.

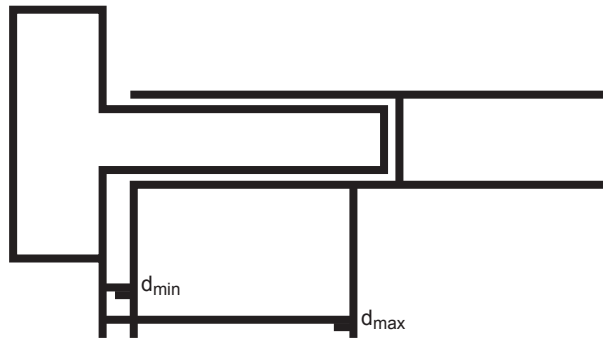

Fig. 5-1 : Mechanical displacement of the measurement tube

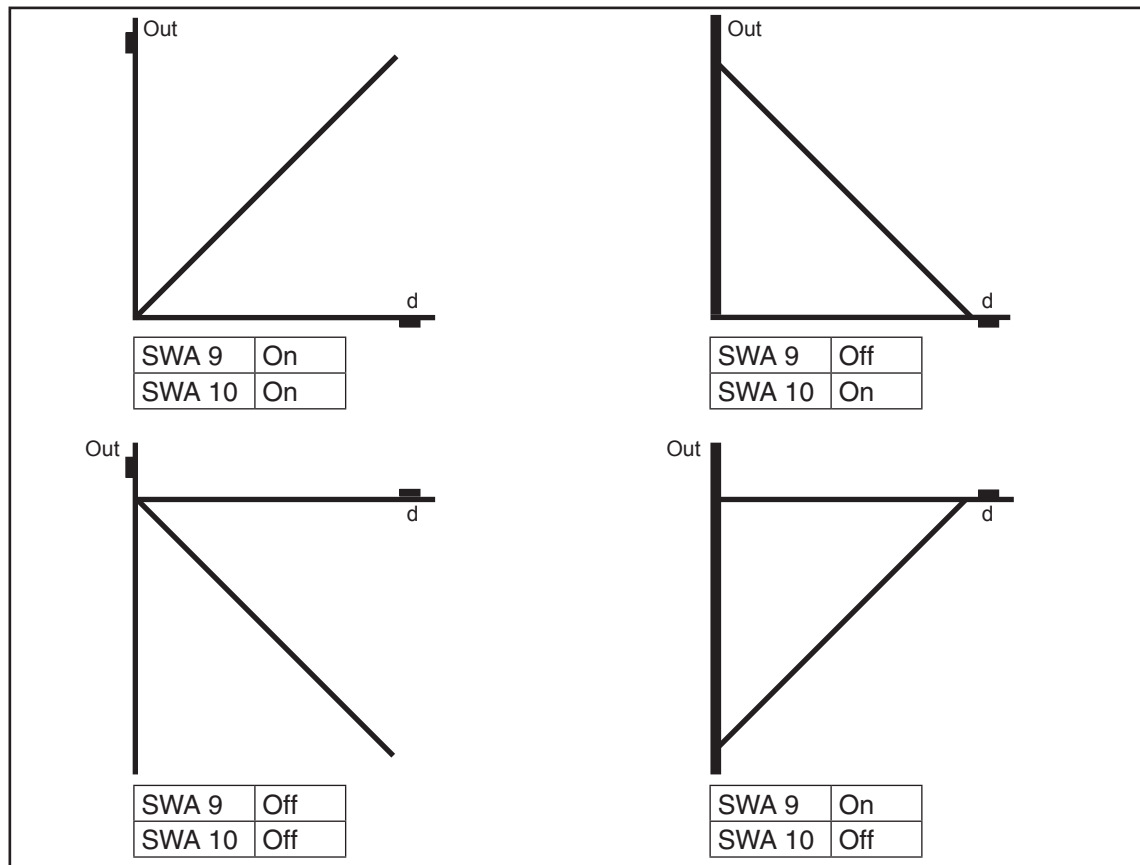

Fig. 5-2 : SWA 9 and SWA 10 micro-switch configuration.

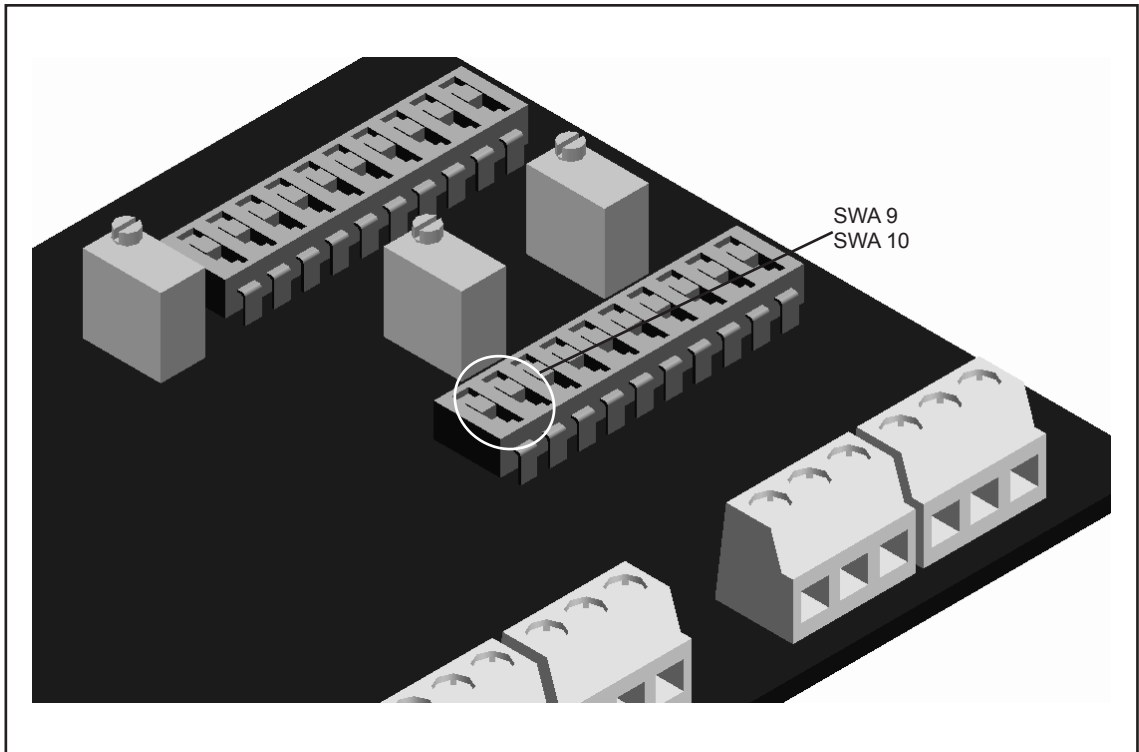

Fig. 5-3 : Micro-switch location on the circuit board.

5.1.2 Measurement tube pulled out corresponding to the reference 0

The figures 5-4 and 5-5 allows one to determine the micro-switch positions for a given customer application. Refer to figure 5-3 for the micro-switch location on the circuit board.

5.2 Micro-switch configuration for a voltage output

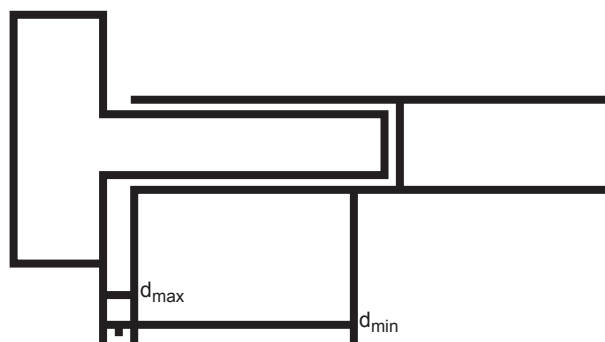

Fig. 5-4 : Mechanical displacement of the measurement tube.

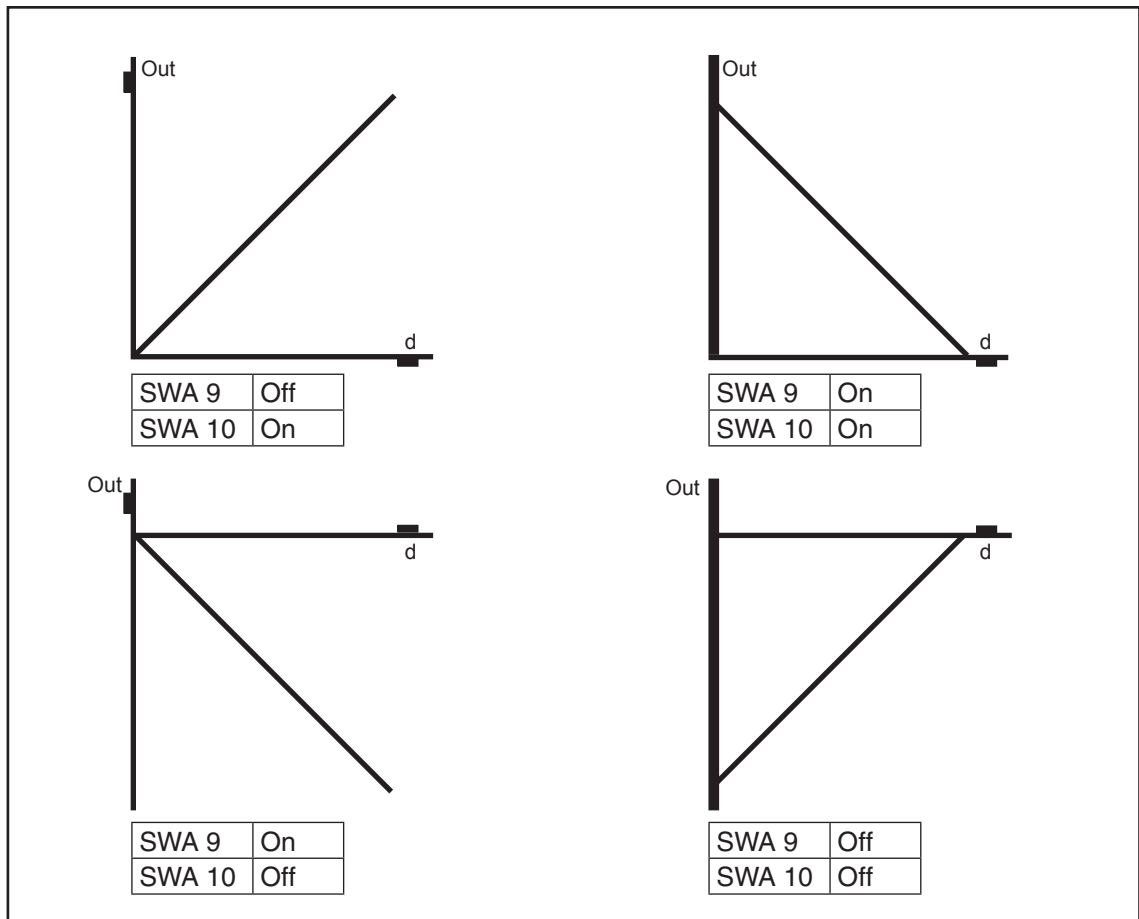

Fig. 5-5 : SWA 9 and SWA 10 micro-switch configuration.

5.2.1 Voltage output with a DI transducer

To carry out a voltage output configuration according to the selected application, proceed as described here :

- Determining the output sensitivity : S_{CT} in V/mm.
- Determining the input sensitivity : S_{IP} in mA/mm.
- Determining the ratio $K_T = S_{CT} / S_{IP}$ in V/mA.
- Configuration of the microswitches.

Determining the output sensitivity : S_{CT} in V/mm

The output sensitivity is determined according to the displacement distance measured by the transducer and according to the required full-scale output voltage. The sensitivity is calculated by taking the maximum required voltage (for instance 10 V) and dividing it by the displacement measured by the transducer (for instance 200 mm).

In the example mentioned here, the output sensitivity would be $S_{CT} = 10 \text{ V} / 200 \text{ mm} = 0,05 \text{ V/mm}$.

Determining the input sensitivity : S_{IP} in mA/mm

The following table allows one to determine the input sensitivity $S_{I/P}$ according to the transducer used.

With a DI-512 transducer one would get an input sensitivity of 0.064 mA/mm.

DI - xxx	$S_{I/P}$ (mA/mm)
505	0.32
510	0.16
511	0.1
512	0.064
513	0.04
514	0.0254
515	0.016
516	0.0534

Determining the ratio $K_T = S_{CT} / S_{I/P}$ in V/mA

The ratio K_T is the gain to apply to the input signal in order to get the required output signal. It is determined by dividing the output sensitivity by the input sensitivity.

We therefore get $K_T = S_{CT} / S_{I/P} = 0.05 \text{ V/mm} / 0.064 \text{ mA/mm} = 0.781 \text{ V/mA}$

Micro-switch configuration

Once the gain is known, the micro-switch configuration can be determined by means of the following table and the figure 5-6 indicating the micro-switch location on the circuit board.

The fine adjustment is done by the potentiometer P3 as described in section 5.6.

K_{min} (V/mA)	K_{max} (V/mA)	SWB 1	SWB 2	SWB 3	SWB 4	SWB 5
0.217	0.364	Off	Off	Off	Off	Off
0.346	0.585	On	Off	Off	Off	Off
0.548	0.924	On	On	Off	Off	Off
0.864	1.459	On	On	On	Off	Off
1.387	2.346	On	On	On	On	Off
2.191	3.705	On	On	On	On	On

Micro-switch and potentiometer location on the circuit board

5.2.2 Voltage output with 4 to 20 mA input current source

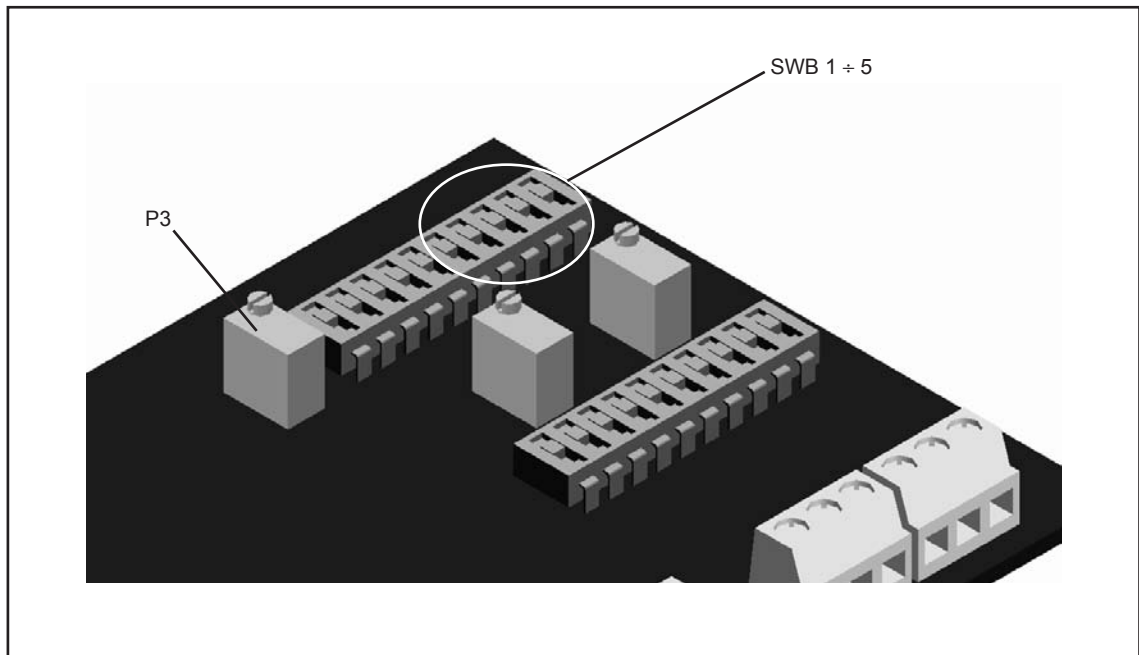

Fig. 5-6 : SWB 1 ÷ 5 micro-switch and P3 potentiometer locations on the circuit board.

To carry out a voltage output configuration according to the selected application, the maximum output voltage has to be defined (for instance 8 V). Then the minimum and maximum input current of the CST 113 must be determined (for instance a range of 6 to 17 mA).

The gain may now be calculated : $K_T = \text{Input} / (\text{Output}_{\max} - \text{Output}_{\min})$. In our example : $K_T = 8 \text{ V} / (17 \text{ mA} - 6 \text{ mA}) = 0.889 \text{ V/mA}$.

Once the gain is known, the micro-switch configuration can be determined by means of the following table and the figure 5-6 indicating the micro-switch location on the circuit board.

The fine adjustment is done by the potentiometer P3 as described in section 5.6.

K_{\min} (V/mA)	K_{\max} (V/mA)	SWB 1	SWB 2	SWB 3	SWB 4	SWB 5
0.217	0.364	Off	Off	Off	Off	Off
0.346	0.585	On	Off	Off	Off	Off
0.548	0.924	On	On	Off	Off	Off
0.864	1.459	On	On	On	Off	Off
1.387	2.346	On	On	On	On	Off
2.191	3.705	On	On	On	On	On

5.3 Micro-switch configuration for a current output

5.3.1 Current output with a DI transducer

To carry out a current output configuration according to the selected application, proceed as described here :

- Determining the output sensitivity : S_{CC} in A/mm.
- Determining the input sensitivity : S_{IP} in mA/mm.
- Determining the ratio $K_T = S_{CC} / S_{IP}$
- Configuration of the microswitches.

Determining the output sensitivity : S_{CC} in A/mm

The output sensitivity is determined according to the displacement distance measured by the transducer and according to the required full-scale output current. The sensitivity is calculated by taking the maximum required current (for instance 17 mA) and dividing it by the displacement measured by the transducer (for instance 200 mm).

In the example mentioned here, the output sensitivity would be $S_{CC} = 17 \text{ mA} / 200 \text{ mm} = 0,085 \text{ mA/mm}$.

Determining the input sensitivity : S_{IP} in mA/mm

The following table allows one to determine the input sensitivity S_{IP} according to the transducer used.

With a DI-512 transducer one would get an input sensitivity of 0.064 mA/mm.

DI - xxx	S_{IP} (mA/mm)
505	0.32
510	0.16
511	0.1
512	0.064
513	0.04
514	0.0254
515	0.016
516	0.0534

Determining the ratio $K_T = S_{CC} / S_{IP}$

The ratio K_T is the gain to apply to the input signal in order to get the required output signal. It is determined by dividing the output sensitivity by the input sensitivity.

We therefore get $K_T = S_{CC} / S_{IP} = 0.085 \text{ mA/mm} / 0.064 \text{ mA/mm} = 1.328$

Micro-switch configuration

Once the gain is known, the micro-switch configuration can be determined by means of the following table and the figure 5-7 indicating the micro-switch location on the circuit board.

The fine adjustment is done by the potentiometer P3 as described in section 5.6.

K_{min}	K_{max}	SWB 1	SWB 2	SWB 3	SWB 4	SWB 5
0.434	0.728	Off	Off	Off	Off	Off
0.692	1.17	On	Off	Off	Off	Off
1.096	1.848	On	On	Off	Off	Off
1.728	2.918	On	On	On	Off	Off
2.774	4.692	On	On	On	On	Off
4.382	7.41	On	On	On	On	On

Micro-switch and potentiometer location on the circuit board

5.3.2 Current output with 4 to 20 mA input current source

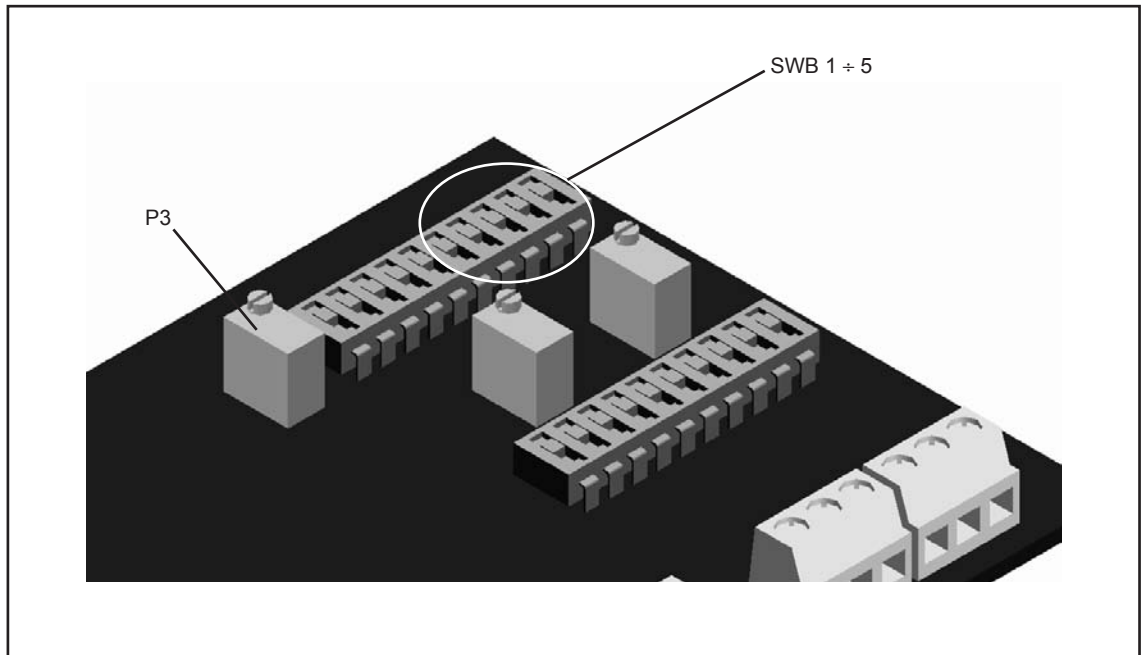

Fig. 5-7 : SWB 1 ÷ 5 micro-switch and P3 potentiometer locations on the circuit board.

To carry out a current output configuration according to the selected application, the maximum output current has to be defined (for instance 15 mA). Then the minimum and maximum input current of the CST 113 must be determined (for instance a range of 6 to 17 mA).

The gain may now be calculated : $K_T = \text{Input} / (\text{Output}_{\text{max}} - \text{Output}_{\text{min}})$. In our example : $K_T = 15 \text{ mA} / (17 \text{ mA} - 6 \text{ mA}) = 1.667$

Once the gain is known, the micro-switch configuration can be determined by means of the following table and the figure 5-7 indicating the micro-switch location on the circuit board.

The fine adjustment is done by the potentiometer P3 as described in section 5.6.

K_{min}	K_{max}	SWB 1	SWB 2	SWB 3	SWB 4	SWB 5
0.434	0.728	Off	Off	Off	Off	Off
0.692	1.17	On	Off	Off	Off	Off
1.096	1.848	On	On	Off	Off	Off
1.728	2.918	On	On	On	Off	Off
2.774	4.692	On	On	On	On	Off
4.382	7.41	On	On	On	On	On

5.4 Adjusting the mechanical zero point

For the mechanical zero point adjustment, the moving element to be measured must be in its minimum position. The adjustment is carried out according to the following procedure :

- Connect a voltmeter between the terminals 4 and 5 (refer to figure 5-8 for the terminal location on the circuit board)
- Make sure that the microswitches SWA 1 to 8 are on position Off (refer to figure 5-9 for the micro-switch location on the circuit board).
- Successively close the microswitches SWA 1 to 8 until the displayed voltage is as close as possible from zero (0V).
- Adjust the potentiometer P1 to get 0 V (± 10 mV max.)

5.5 Offset adjustment

18	Case - GND
17	Temperature I/P
16	Shield
15	Current Signal I/P
14	0 V
13	Transducer Supply

12	OK O/P
11	0 V
10	Temperature O/P
9	0 V
8	Current O/P
7	0 V
6	Voltage O/P
5	0V
4	Zero O/P Adjust

3	0 V (Supply)
2	+24 V (Supply)
1	Case - GND

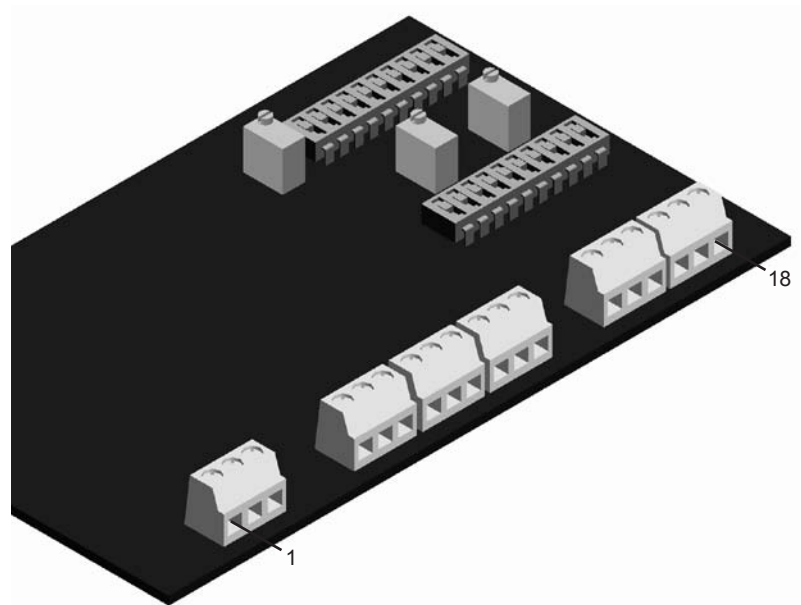

Fig. 5-8 : Connecting terminals

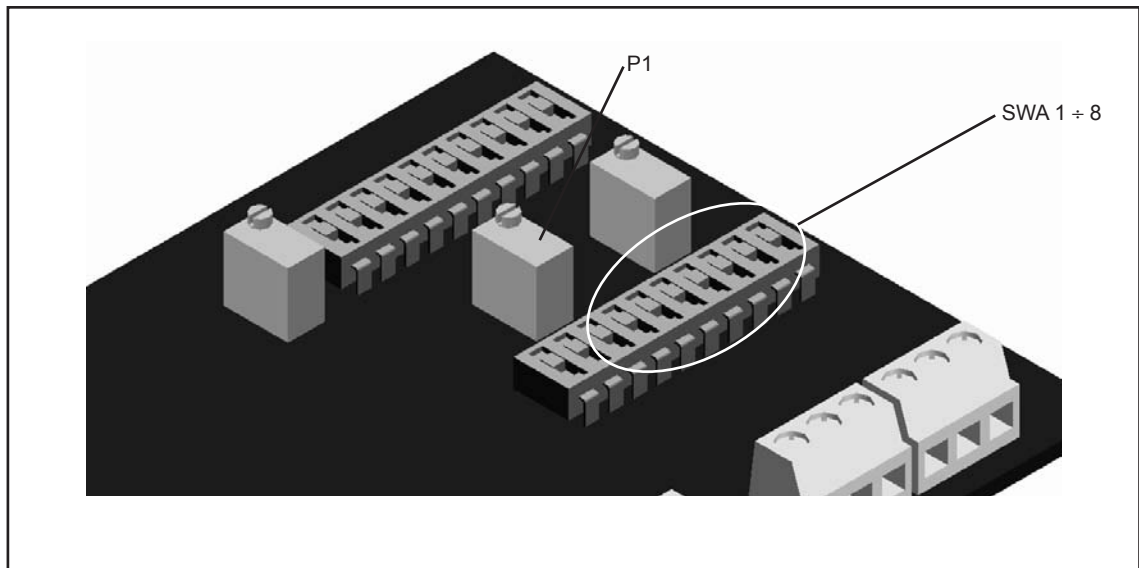

Fig. 5-9 : SWA 1 ÷ 8 micro-switch and P1 potentiometer locations on the circuit board.

After having set the mechanical zero (refer to section 5.4), the moving element to be measured has to remain in its minimum position. The offset adjustment can now be carried out according to the following procedure :

- Connect a voltmeter between the terminals 6 and 7 for a voltage output or an amperemeter between the terminals 7 and 8 for a current output (refer to figure 5-8 for the terminal location on the circuit board).
- Make sure that the microswitches SWB 6 to 10 are on position Off (refer to figure 5-10 for the micro-switch location on the circuit board).
- Successively close the microswitches SWB 6 to 10 until the displayed voltage or current (according to the application) is as close as possible to the requested value (for instance 4 V in minimum position).
- Precisely adjust the voltage or the current with the potentiometer P2.

5.6 Precise adjustment of the gain

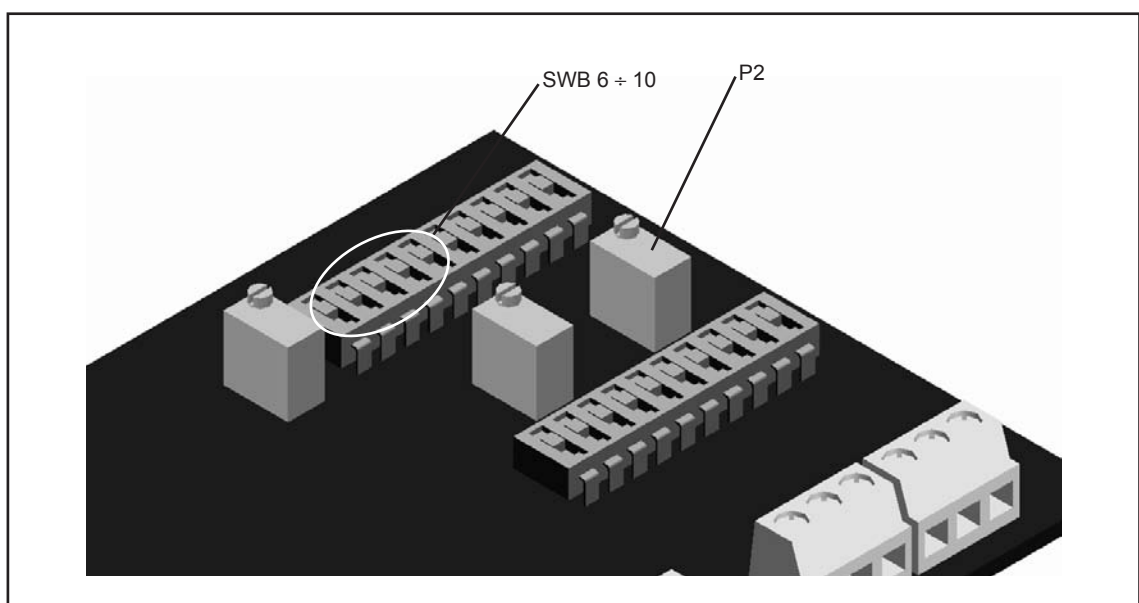

Fig. 5-10 : SWB 6 ÷ 10 micro-switch and P2 potentiometer locations on the circuit board.

The gain range has been determined in section 5.2 or 5.3. To adjust the gain with precision, the moving element must be in its maximum position. The adjustment can now be carried out according to the following procedure :

- Connect a voltmeter between the terminals 6 and 7 for voltage output or an amperemeter between the terminals 7 and 8 for current output (refer to figure 5-11 for the terminal location on the circuit board).
- Precisely adjust the voltage (for instance 8 V in the maximum position) or the current with the potentiometer P3 (refer to figure 5-12 for the potentiometer location on the circuit board).

5.7 CST 113 configuration in a single stroke

18	Case - GND
17	Temperature I/P
16	Shield
15	Current Signal I/P
14	0 V
13	Transducer Supply

12	OK O/P
11	0 V
10	Temperature O/P
9	0 V
8	Current O/P
7	0 V
6	Voltage O/P
5	0V
4	Zero O/P Adjust

3	0 V (Supply)
2	+24 V (Supply)
1	Case - GND

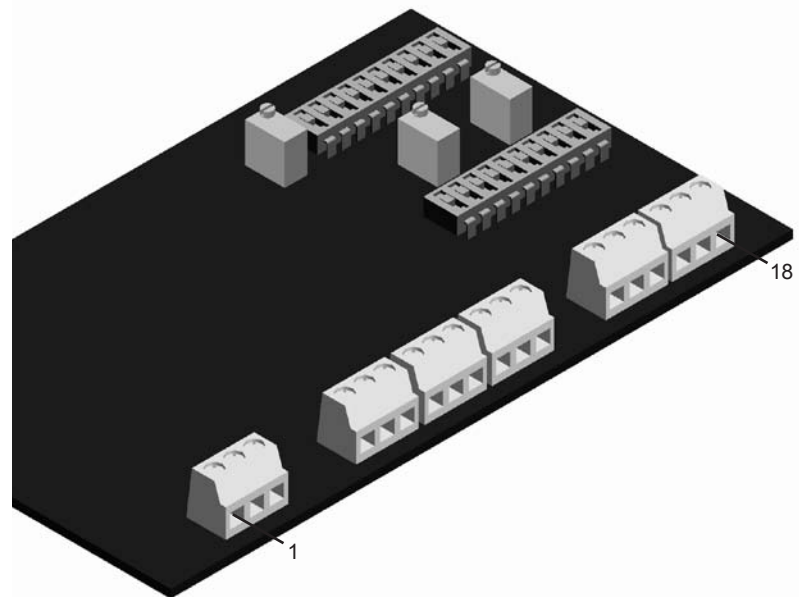

Fig. 5-11 : Connecting terminals

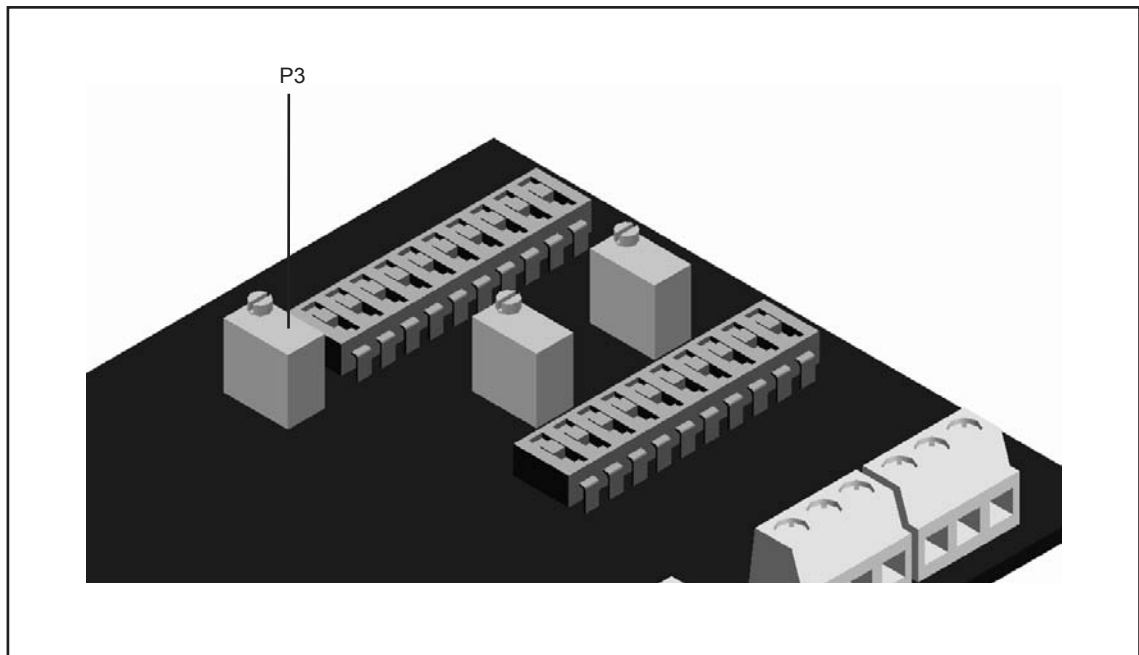

Fig. 5-12 : Potentiometer P3 location on the circuit board.

The CST 113 configuration can be completed in a single stroke from the maximum to the minimum position. To carry out this operation proceed as follows :

- Configuration of the micro-switch according to the sections 5.2 or 5.3
- **Displacement of the moving element in minimum position**
- Adjustment of the mechanical zero according to section 5.4
- Adjustment of the offset according to section 5.5
- **Displacement of the moving element in maximum position**
- Adjustment of the output signal to the required value for the maximum position according to section 5.6

5.8 Micro-switch and potentiometer functions

SWA 1 to 8 : mechanical zero adjustment
 SWA 9 : output signal slope
 SWA 10 : output polarity
 SWB 1 to 5: gain configuration
 SWB 6 to 10 : offset adjustment

P1 : precise mechanical zero adjustment
 P2 : precise offset adjustment
 P3 : precise gain adjustment

5.9 Transmission OK

An open collector type output is available on the terminal (Open or Closed via 0 V). The output follows the logic described hereafter :

Normal operation : **Closed**

The current coming from the DI 5xx is in an acceptable range (for example 2 mA to 22 mA) and the consumed current on the "Transducer supply" terminal is < 80 mA DC

Default operation : **Open**

There is a short circuit on the DI 5xx supply unit or a defect on the DI 5xx connecting line (anomalies concerning the temperature information are not taken into account).



The Transmission OK signal does not interfere with the transmission chain.

A CONNECTION CABLES

This appendix contains the connection cable drawings.

Designation	Drawing Nr.
Cable assemblies for DI 51X	943-144-000 V 001
Cable assemblies for DI 51X	943-145-000 V 001

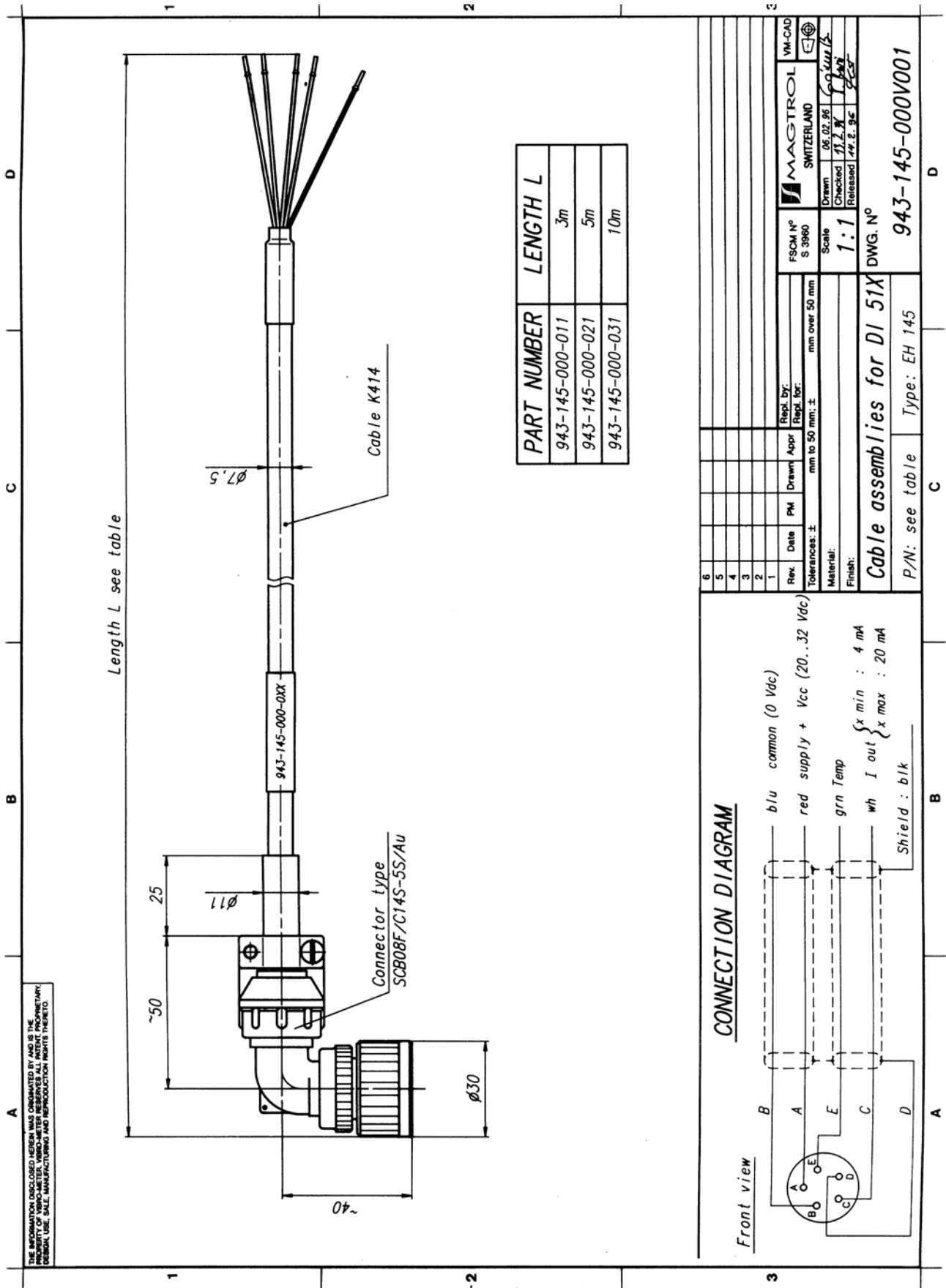

Service Information

RETURNING MAGTROL EQUIPMENT FOR REPAIR AND/OR CALIBRATION

Before returning equipment to Magtrol for repair and/or calibration, please visit Magtrol's Web site at <http://www.magtrol.com/support/rma.htm> to begin the Return Material Authorization (RMA) process. Depending on where the equipment is located and which unit(s) will be returned, you will be directed to either ship your equipment back to Magtrol, Inc. in the United States or Magtrol SA in Switzerland.

Returning Equipment to Magtrol, Inc. (United States)

When returning equipment to Magtrol, Inc.'s factory in the United States for repair and/or calibration, a completed Return Material Authorization (RMA) form is required.

1. Visit Magtrol's Web site at <http://www.magtrol.com/support/rma.htm> to begin the RMA process.
2. Complete the RMA form online and submit.
3. An RMA number will be issued to you via e-mail. Include this number on all return documentation.
4. Ship your equipment to:
MAGTROL, INC.
70 Gardenville Parkway
Buffalo, NY 14224
Attn: Repair Department
5. After Magtrol's Repair Department receives and analyzes your equipment, a quotation listing all the necessary parts and labor costs, if any, will be faxed or e-mailed to you.
6. After receiving your repair estimate, provide Magtrol with a P.O. number as soon as possible. A purchase order confirming the cost quoted is required before your equipment can be returned.

Returning Equipment to Magtrol SA (Switzerland)

If you are directed to ship your equipment to Switzerland, no RMA form/number is required. Just send your equipment directly to Magtrol SA in Switzerland and follow these shipment instructions:

1. Ship your equipment to:
MAGTROL SA
After Sales Service
Route de Montena 77
1728 Rossens / Fribourg
Switzerland
VAT No: 485 572
2. Please use our forwarder : TNT • 1-800-558-5555 • Account No 154033
Only ship ECONOMIC way (3 days max. within Europe)
3. Include the following documents with your equipment:
 - Delivery note with Magtrol SA's address (as listed above)
 - Three pro forma invoices with:
 - Your VAT number
 - Description of returned goods
 - Noticed failures
 - Value - for customs purposes only
 - Origin of the goods (in general, Switzerland)
4. A cost estimate for repair will be sent to you as soon as the goods have been analyzed. If the repair charges do not exceed 25% the price of a new unit, the repair or calibration will be completed without requiring prior customer authorization.



Testing, Measurement and Control of Torque-Speed-Power • Load-Force-Weight • Tension • Displacement

www.magtrol.com

MAGTROL INC

70 Gardenville Parkway
Buffalo, New York 14224 USA
Phone: +1 716 668 5555
Fax: +1 716 668 8705
E-mail: magtrol@magtrol.com

MAGTROL SA

Route de Montena 77
1728 Rossens/Fribourg, Switzerland
Phone: +41 (0)26 407 3000
Fax: +41 (0)26 407 3001
E-mail: magtrol@magtrol.ch

Subsidiaries in:

Germany • France
China • India

Worldwide Network
of Sales Agents

