

LE 210 and LU 210 Series Load Measuring Pins

FEATURES

- Temperature-compensated transducers with strain gauges in full-bridge configuration.
- Available in 9 standard ranges from 5 kN to 1250 kN (0.56 tf to 140.5 tf).
- Integrated 2-wire (LE) or 4-wire (LU) electronics for transmission over great distances.
- EMC execution for reliable trouble-free operation.
- Rugged design corresponding to the quality characteristics of LB 210 series.
- Insensitive to external mechanical and chemical effects.
- Ideal for use in hostile environments.
- Simple installation for cost-saving solutions to construction problems.
- Calibrated Output: 0–10 VDC (LU); 4–20 mA (LE)

DESCRIPTION

Magtrol Load Measuring Pins are used to measure load and force and provide overload protection. The pins are mounted into machines in place of normal shafts and fitted with strain gauges, allowing them to produce a signal proportional to the measured load. Manufactured in Switzerland, Magtrol's LE/LU 210 Series Load Pins (the result of continual development of the well-established LB Series) are rugged with high resistance stainless steel and tight construction. Available in 9 standard ranges from 5 kN to 1250 kN, their operation remains trouble-free and reliable even in electromagnetically difficult environmental conditions.

Magtrol Load Measuring Pins can be used alone or as part of a complete measurement system. Magtrol offers a wide range of Load-Force-Weight Transducers in various executions and accuracy classes and our Load Monitoring Units (LMUs) constitute an ideal safe measurement system which continuously checks for overloads and short circuits.

DESIGN

The load measuring pin has 2 circular grooves and an axial bore. The strain gauges are mounted in a full-bridge configuration, inside the central bore, adjacent to the external grooves. This ensures they are insensitive to external mechanical and chemical effects. The positioning and orientation of the strain gauges has been optimized by means of the finite element method (FEM).



*Model LE or LU 214
Load Measuring Pin*

APPLICATIONS

When forces acting on mechanical constructions are measured, the additional equipment required can often be costly and difficult to install. Magtrol Load Measuring Pins offer an excellent solution since they act as a direct element in the assembly, replacing a non-instrumented pin or shaft. LE/LU 210 Series Load Pins are used for load measuring devices and overload protection on cranes, hoisting gear, elevators and winches. The integrated electronics makes it ideal for applications in which separate signal conditioning is difficult to install and where the monitoring electronics are positioned at extended distances.

MOUNTING EXAMPLE

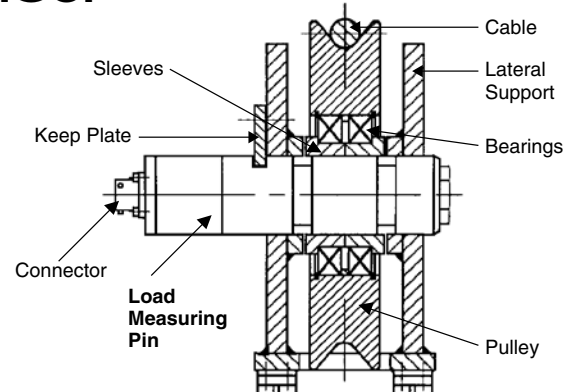

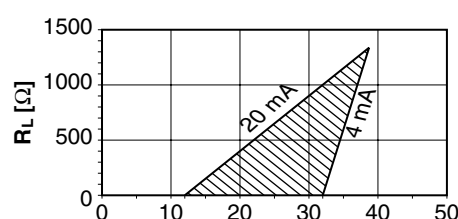
Standard Version*	LE 211	LE 212	LE 213	LE 214	LE 216	LE 217	LE 218	LE 220	LE 221
MECHANICAL CHARACTERISTICS									
Nominal Load, fsd (Metric)	5 kN	10 kN	20 kN	50 kN	100 kN	200 kN	500 kN	1000 kN	1250 kN
Nominal Load, fsd (US)	0.56 tf	1.12 tf	2.25 tf	5.62 tf	11.24 tf	22.48 tf	56.20 tf	112.4 tf	140.5 tf
Overload Admissible	150% of rated load without influence on measurement								
Overload at Rupture (of rated load)	≥ 500%						400%	350%	
Material	LE load measuring pin: Stainless steel 1.4057 LE transmitter housing: Stainless steel 1.4305								
EMC	According to EN 6100-6-2 & EN 6100-6-4 category B								
Protection Class	IP 66 according to DIN 40050								
Lubrication	not available				Oiler ø4 DIN 3405 D or M10 DIN 3405 A according to the LE model (option)				
ELECTRICAL CHARACTERISTICS									
Operating Principle	Full-bridge strain gauge								
Strain Gauge Bridge Impedance	5000 Ω								
Output Signal	Rated 4 to 20 mA; max. 3.5 to 25 mA								
Power Supply	12 to 32 VDC with protected polarity reversal < 35 mA								
Non-linearity Error	< 0.25% of fsd							< 0.5% of fsd	
Non-linearity + Hysteresis Error	< 0.5% of fsd							< 0.8% of fsd	
Repeatability	± 0.1% of fsd								
Operating Temperature	-25°C to +80°C								
Storage Temperature	-55°C to +125°C								
Temperature Influence: • On Zero • On Sensitivity	± 0.02% of fsd / K ± 0.02% / K								
Long Term Stability • Of Zero • Of Sensitivity	< 1% of fsd / year (not cumulative) < 0.5% / year (not cumulative)								
Influence on Measurement Signal (Shift of Force Angle with Respect to Measurement Axis)	According to the cosine function								
Standard Calibration	0 kN = 4 mA fsd in kN = 20 mA								
ELECTRICAL CONNECTION									
Output Connector	Axial, MS 3112 E 10-6P								
Configuration	2-wire								
Connection Cable Assembly	3 m, 6 m, 12 m or 20 m Cable with: Straight Connector, MS 3116 J10 6S or 90° Connector, Souriau 851 08 EC 10 6S50								
Load Resistance	<p>Admissible resistance of the 2-wire circuit at the connection of the LE 210</p> <div style="display: flex; align-items: center;"> <div style="margin-right: 20px;"> $\text{Hatched Operating Domain} = \frac{\text{Load Resistance } R_L}{\text{Supply Voltage } U_a}$ </div>  </div>								

* Ratings apply to standard load pins only, special models are available by contacting Magtrol.

Standard Version*	LU 211	LU 212	LU 213	LU 214	LU 216	LU 217	LU 218	LU 220	LU 221
MECHANICAL CHARACTERISTICS									
Nominal Load, fsd (Metric)	5 kN	10 kN	20 kN	50 kN	100 kN	200 kN	500 kN	1000 kN	1250 kN
Nominal Load, fsd (US)	0.56 tf	1.12 tf	2.25 tf	5.62 tf	11.24 tf	22.48 tf	56.20 tf	112.4 tf	140.5 tf
Overload Admissible	150% of rated load without influence on measurement								
Overload at Rupture (of rated load)	≥ 500%						400%	350%	
Material	LU load measuring pin: Stainless steel 1.4057 LU transmitter housing: Stainless steel 1.4305								
EMC	According to EN 6100-6-2 & EN 6100-6-4 category B								
Protection Class	IP 66 according to DIN 40050								
Lubrication	not available				Oiler ø4 DIN 3405 D or M10 DIN 3405 A according to the LU model (option)				
ELECTRICAL CHARACTERISTICS									
Operating Principle	Full-bridge strain gauge								
Strain Gauge Bridge Impedance	350 Ω								
Output Signal	0–10 V								
Power Supply	12 to 32 VDC with protected polarity reversal < 35 mA								
Non-linearity Error	< 0.25% of fsd							< 0.5% of fsd	
Non-linearity + Hysteresis Error	< 0.5% of fsd							< 0.8% of fsd	
Repeatability	± 0.1% of fsd								
Operating Temperature	-25°C to +80°C								
Storage Temperature	-55°C to +125°C								
Temperature Influence: • On Zero • On Sensitivity	± 0.02% of fsd / K ± 0.02% / K								
Long Term Stability • Of Zero • Of Sensitivity	< 1% of fsd / year (not cumulative) < 0.5% / year (not cumulative)								
Influence on Measurement Signal (Shift of Force Angle with Respect to Measurement Axis)	According to the cosine function								
Standard Calibration	0 kN = 0 V fsd in kN = 10 V								
ELECTRICAL CONNECTION									
Output Connector	Axial, MS 3112 E 10-6P								
Configuration	4-wire								
Connection Cable Assembly	3 m, 6 m, 12 m or 20 m Cable with: Straight Connector, MS 3116 J10 6S or 90° Connector, Souriau 851 08 EC 10 6S50								

* Ratings apply to standard load pins only, special models are available by contacting Magtrol.

OPERATING PRINCIPLE

When force is applied to the Load Measuring Pin along its sensitive axis, the effect on the strain gauge bridge results in an output signal proportional to the applied force. The signal is then converted by the integrated electronics to a standard 4 to 20 mA (LE) or 0–10V (LU) output. Based on SMD (surface mounted device) technology, the electronics are well-protected against conducted and radiated electromagnetic fields.

R_a should equal R_b so that the force is evenly distributed.

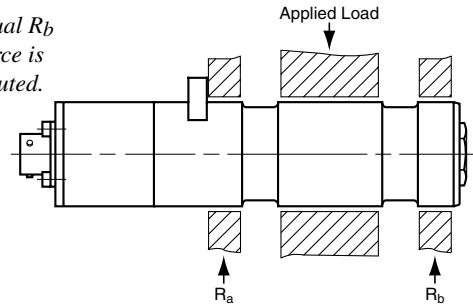

DIMENSIONS

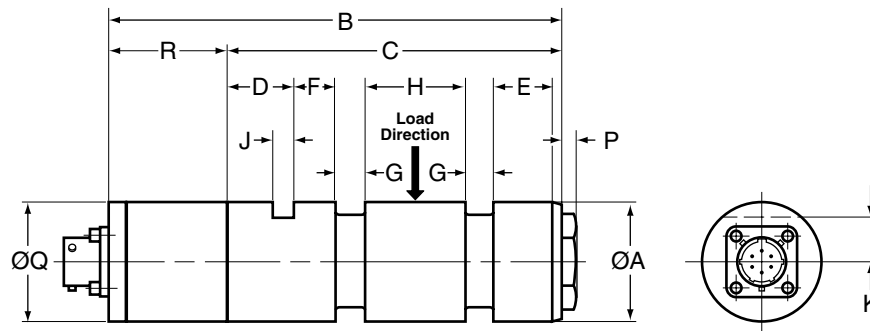

NOTE:

Original dimensions are in Metric units. Dimensions converted to English units have been rounded up to 3 decimal places.

Model	units	$\varnothing A$	B	C	D	E	F	G	H	J	K	P	$\varnothing Q$	R	Weight
LE/LU 211	mm	25h6	136	84	18	16	10	7	24	5.2	9	3	38	52	0.6 kg
	in	0.984	5.354	3.307	0.709	0.63	0.394	0.276	0.945	0.205	0.354	0.118	1.496	2.047	1.323 lb
LE/LU 212	mm	25h6	136	84	18	16	10	7	24	5.2	9	3	38	52	0.6 kg
	in	0.984	5.354	3.307	0.709	0.63	0.394	0.276	0.945	0.205	0.354	0.118	1.496	2.047	1.323 lb
LE/LU 213	mm	25h6	136	84	18	16	10	7	24	5.2	9	3	38	52	0.6 kg
	in	0.984	5.354	3.307	0.709	0.63	0.394	0.276	0.945	0.205	0.354	0.118	1.496	2.047	1.323 lb
LE/LU 214	mm	35h6	149	112	25	14	12	12	35	6.3	11.5	3	38	37	1.05 kg
	in	1.378	5.866	4.409	0.984	0.551	0.472	0.472	1.378	0.248	0.453	0.118	1.496	1.457	2.315 lb
LE/LU 216	mm	50h6	198	161	32	24	18	18	48	10.5	20	3	38	37	2.4 kg
	in	1.969	7.795	6.339	1.26	0.945	0.709	0.709	1.89	0.413	0.787	0.118	1.496	1.457	5.291 lb
LE/LU 217	mm	65h6	233	196	32	26	20	25	65	10.5	22.5	3	38	37	4.8 kg
	in	2.559	9.173	7.717	1.26	1.024	0.787	0.984	2.559	0.413	0.886	0.118	1.496	1.457	10.582 lb
LE/LU 218	mm	85h6	295	258	34	39	35	28	89	10.5	28	3	38	37	11 kg
	in	3.347	11.614	10.158	1.339	1.535	1.378	1.102	3.504	0.413	1.102	0.118	1.496	1.457	24.251 lb
LE/LU 220	mm	100h6	384	347	36	61	55	35	120	10.5	36	3	38	37	19.6 kg
	in	3.937	15.118	13.661	1.417	2.402	2.165	1.378	4.724	0.413	1.417	0.118	1.496	1.457	43.211 lb
LE/LU 221	mm	120h6	384	347	36	61	55	35	120	12.5	40	3	38	37	28.8 kg
	in	4.724	15.118	13.661	1.417	2.402	2.165	1.378	4.724	0.492	1.575	0.118	1.496	1.457	63.493 lb

OPTIONS AND ORDERING INFORMATION

LE SERIES LOAD MEASURING PINS

- Model LE 2 - 2 _____ LE 2 / 0 3
- Lubrication (LE 211-221): Without _____ 1
- (LE 216-221): With _____ 3

Example

An LE 216 Load Measuring Pin with lubrication would be ordered as LE 216/033.

LU SERIES LOAD MEASURING PINS

- Model LU 2 - 2 _____ LU 2 / 1 1
- Lubrication (LU 211-221): Without _____ 1
- (LU 216-221): With _____ 3

Example

An LU 216 Load Measuring Pin with lubrication would be ordered as LU 216/131.

ACCESSORIES

Cable Assemblies

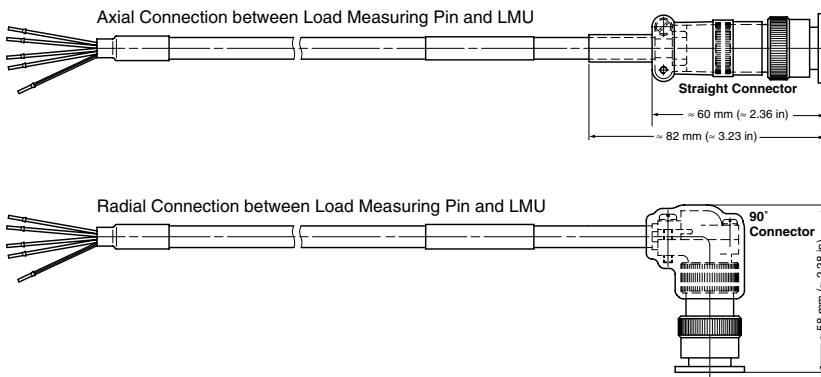

Accessory Ordering Information

COUNTER-CONNECTOR

Straight Connector P/N 957.11.08.0030

90° Connector P/N 957.11.08.0029

CONNECTION CABLE ASSEMBLY

Part Number EH 13 / 0 1

- Straight Connector _____ 8
- 90° Connector _____ 9

CONNECTION CABLE ASSEMBLY

Cable Length: 3 m _____ 1
 6 m _____ 2
 12 m _____ 3
 20 m _____ 4

LE Pin Configuration

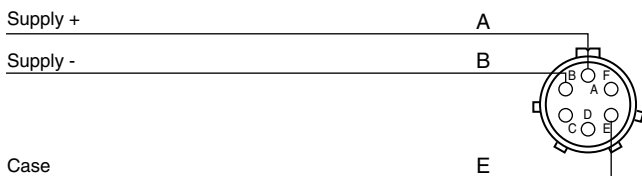

LU Pin Configuration

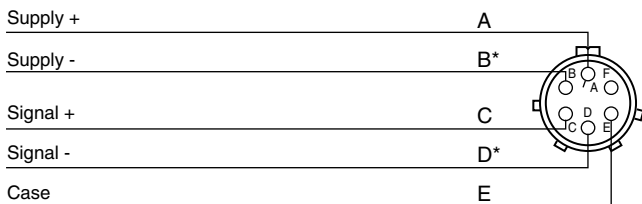

***NOTE:**

Pins B and D are connected together. This feature allows the user to cancel the voltage drop error due to the supply current on the cable (4-wire measurement).

Due to the continual development of our products, we reserve the right to modify specifications without forewarning.



www.magtrol.com

MAGTROL INC

70 Gardenville Parkway
 Buffalo, New York 14224 USA
 Phone: +1 716 668 5555
 Fax: +1 716 668 8705
 E-mail: magtrol@magtrol.com

MAGTROL SA

Centre technologique Montena
 1728 Rossens/Fribourg, Switzerland
 Phone: +41 (0)26 407 3000
 Fax: +41 (0)26 407 3001
 E-mail: magtrol@magtrol.ch

Subsidiaries in:

Great Britain
 Germany • France
 China • India
 Worldwide Network
 of Sales Agents

